

# Stelsel Toegang - SAML

Logius Guide

Draft June 03, 2026

**This version:**

<https://logius-standaarden.github.io/st-saml-spec/>

**Latest published version:**

<https://gitdocumentatie.logius.nl/publicatie/st/saml/>

**Latest editor's draft:**

<https://logius-standaarden.github.io/st-saml-spec/>

**Editor:**

Frans de Kok ([Logius](#))

**Authors:**

Frans de Kok ([Logius](#))

Jan Geert Koops ([DICTU](#))

Mark Nijmeijer ([DICTU](#))

Wiljan Pitlo ([ICTU](#))

Carlo Huiden ([ICTU](#))

**Participate:**

[GitHub Logius-standaarden/st-saml-spec](https://github.com/logius-standaarden/st-saml-spec)

[All issues](#)

[File an issue](#)

[Commit history](#)

[Pull requests](#)

This document is also available in these non-normative formats: [Versie voor dienstverleners](#) and [PDF](#)



This document is licensed under  
[Creative Commons Attribution 4.0 International Public License](#)

## Status of This Document

This is a draft that could be altered, removed or replaced by other documents. It is not a recommendation approved by TO.

## Table of Contents

### Status of This Document

### Conformance

### Abstract

#### 1. Disclaimer

#### 2. History

#### 3. Glossary

##### 3.1 Terms

##### 3.2 Roles

#### 4. Introduction

#### 5. Frameworks

##### 5.1 SAML generic

##### 5.2 DV - SAML message flows & bindings

###### 5.2.1 DV → RD authentication flow

###### 5.2.1.1 Front-channel (re)authentication

- 5.2.1.2 Back-channel (Assertion)
- 5.2.2 DV → RD Federated Logout flow
- 5.3 RD - SAML message flows & bindings
- 5.3.1 RD → AD authentication flow
- 5.3.1.1 Front-channel (re)authentication
- 5.3.1.2 Back-channel (Assertion)
- 5.3.2 RD - AD Single Logout

## 6. Supported Use Cases

- 6.1 Authentication
  - 6.1.1 Actors
  - 6.1.2 Functional description
- 6.2 Authentication with representation
  - 6.2.1 standard representation
  - 6.2.2 legal representation
  - 6.2.3 Actors
  - 6.2.4 Functional description
- 6.3 Cluster connection connectivity
  - 6.3.1 Actors
  - 6.3.2 Technical description
- 6.4 Authentication with AD/BVD preselection
  - 6.4.1 Actors
  - 6.4.2 Functional description

## 7. Message Specification

- 7.1 DV - SAML Message specification
  - 7.1.1 DV → RD - SAML authentication proces
    - 7.1.1.1 DV → RD - authentication - diagram
    - 7.1.1.2 DV → RD - authentication - steps
  - 7.1.2 DV → RD - SAML messages
    - 7.1.2.1 DV → RD AuthnRequest
      - 7.1.2.1.1 DV → RD AuthnRequest Diagram
      - 7.1.2.1.2 DV → RD AuthnRequest Message
      - 7.1.2.1.3 DV → RD AuthnRequest Processing rules
    - 7.1.2.2 DV ← RD Artifact Binding
      - 7.1.2.2.1 DV → RD - Artifact Binding - Diagram
      - 7.1.2.2.2 DV → RD - Artifact Binding - Message
    - 7.1.2.3 DV → RD ArtifactResolve
      - 7.1.2.3.1 DV → RD ArtifactResolve Diagram
      - 7.1.2.3.2 DV → RD ArtifactResolve Message
    - 7.1.2.4 DV ← RD ArtifactResponse
      - 7.1.2.4.1 DV → RD ArtifactResponse Diagram
      - 7.1.2.4.2 DV → RD ArtifactResponse Message
      - 7.1.2.4.3 DV → RD AuthN Response - Message
      - 7.1.2.4.4 DV → RD AuthN Response - Assertion
      - 7.1.2.4.5 AttributeStatement - DV
      - 7.1.2.4.6 EncryptedID
- 7.2 RD - SAML Message specification
  - 7.2.1 RD → AD - SAML authentication proces
    - 7.2.1.1 RD → AD - Authentication - diagram
    - 7.2.1.2 RD → AD - Authentication - steps
    - 7.2.1.3 RD → AD/BVD ArtifactResolve
  - 7.2.2 RD → AD - SAML messages
    - 7.2.2.1 RD → AD AuthnRequest
      - 7.2.2.1.1 RD → AD AuthnRequest Diagram
      - 7.2.2.1.2 RD → AD AuthnRequest Message
      - 7.2.2.1.3 AuthN-Request differences between DV/LC → RD, RD → AD and RD → BVD
      - 7.2.2.1.4 RD → AD AuthnRequest Processing rules
    - 7.2.2.2 RD ← AD Response - Artifact Binding
      - 7.2.2.2.1 RD → AD Response - Artifact Binding - Diagram{#rd-response-artifact-binding}
      - 7.2.2.2.2 RD → AD Response - Artifact Binding - Message

- 7.2.2.3 RD → AD ArtifactResolve
- 7.2.2.3.1 RD → AD ArtifactResolve Diagram
- 7.2.2.3.2 RD → AD ArtifactResolve Message
- 7.2.2.4 RD → AD ArtifactResponse
- 7.2.2.4.1 RD → AD ArtifactResponse Diagram
- 7.2.2.4.2 RD → AD Artifact Response Message
- 7.2.2.4.3 RD → AD AuthN Response - Message
- 7.2.2.4.4 RD → AD AuthN Response - Assertion
- 7.2.2.4.5 Assertion and AttributeStatement differences between DV/LC → RD and RD → AD/BVD

### 7.3 Federated Logout Message specification

- 7.3.1 DV → RD login & logout
  - 7.3.1.1 DV Federated Login
  - 7.3.1.2 DV → RD logout Request - Diagram
  - 7.3.1.3 DV → RD logout Request - Message
  - 7.3.1.4 DV → RD logout Response - Diagram
  - 7.3.1.5 DV → RD logout Response - Message
- 7.3.2 RD → AD login & logout
  - 7.3.2.1 RD → AD logout Request - Diagram
  - 7.3.2.2 RD → AD logout Request - Message
  - 7.3.2.3 RD → AD logout Response - Diagram
  - 7.3.2.4 RD → AD logout Response - Message

### 7.4 Error messages

- 7.4.1 Toplevel codes
- 7.4.2 Second-level status codes
- 7.4.3 Cancelling
- 7.4.4 Attributes not supported
- 7.4.5 Incorrect message (recoverable)
- 7.4.6 Incorrect message (non-recoverable)

## 8. SAML Metadata

- 8.1 Metadata
  - 8.1.1 TLS certificates in metadata
  - 8.1.2 General processing requirements
- 8.2 DV Metadata
  - 8.2.1 DV → RD Metadata
  - 8.2.2 LC → RD metadata
    - 8.2.2.1 LC → RD EntityDescriptor
    - 8.2.2.2 DV → RD EntityDescriptor
  - 8.2.3 RD → DV/LC metadata
- 8.3 RD metadata
  - 8.3.1 RD → AD metadata
    - 8.3.1.1 EntityDescriptor
    - 8.3.1.2 DV → AD EntityDescriptor
  - 8.3.2 AD/BVD → RD metadata

## 9. Technical requirements and recommendations

- 9.1 Signing, encryption algorithms and hash functions
- 9.2 Signature
- 9.3 Encryption
- 9.4 TLS transport
- 9.5 NotBefore and NotOnOrAfter
- 9.6 Levels of assurance
- 9.7 Local session
- 9.8 RelayState
- 9.9 EU interaction

## 10. Type definitions

- 10.1 Attribute identifier types
- 10.2 Attribute representation types
- 10.3 EntityID Format

10.4	Level of Assurance
<b>A.</b>	<b>Example SAML messages</b>
A.1	Example - AuthnRequest
A.2	Example - AuthnRequest using Extensions
A.3	Example - AuthnRequest with Representation
A.4	Example - ArtifactResponse with Legal Representation
A.5	Example - ArtifactResolve
A.6	Example - ArtifactResponse
A.7	Example - ArtifactResponse with Representation
A.8	Example - LogoutRequest
A.9	Example - LogoutResponse
<b>B.</b>	<b>Example SAML metadata</b>
B.1	Example - Metadata DV for RD
B.2	Example - Metadata LC for RD
B.3	Example - Metadata RD for DV
<b>C.</b>	<b>List of Figures</b>
<b>D.</b>	<b>Index</b>
D.1	Terms defined by this specification
D.2	Terms defined by reference
<b>E.</b>	<b>References</b>
E.1	Normative references

## § Conformance

As well as sections marked as non-normative, all authoring guidelines, diagrams, examples, and notes in this specification are non-normative. Everything else in this specification is normative.

The key words *MAY*, *MUST*, *MUST NOT*, *SHOULD*, and *SHOULD NOT* in this document are to be interpreted as described in [BCP 14 \[RFC2119\]](#) [[RFC8174](#)] when, and only when, they appear in all capitals, as shown here.

## Abstract

This specification is intended for service providers ([DV](#)) who want to connect their webservice to [DigiD](#) and optionally [DigiD-Machtigen](#) and [BVD-OG](#) via a [RD](#) like [TVS](#).

## §1. Disclaimer

This version of the document must not in any way be considered to be a normative source for the purpose of conducting audits on [participants](#). This topic will be addressed in future versions.

Errata, functional improvements and other developments will be added to this documentation in future versions. Version history for this document is included on the [History](#) page.

## §2. History

Version	Changes	Distribution
[ <a href="#">ST-SAML1.0</a> ] RC 1	Release Candidate 1: derived from [ <a href="#">eID SAML4.4</a> ] Final with the following additional changes	Internal

Version	Changes	Distribution
	<ul style="list-style-type: none"> <li>Added support for <a href="#">BVD-OG</a> in support of Stelsel Toegang release 1.</li> <li>Added specifications for connection between <a href="#">RD</a> and <a href="#">AD/BVD</a>, based on [<a href="#">eID SAML4.5</a>] specification</li> <li>Change of structure to introduce two versions <ul style="list-style-type: none"> <li>Short version only covering <a href="#">DV</a> and <a href="#">LC</a> connecting to an <a href="#">RD</a> (e.g. <a href="#">TVS</a>)</li> <li>Complete version also covering connections between <a href="#">RD</a> and <a href="#">AD/BVD</a></li> </ul> </li> <li>All parts have been revised for improved clarity and consistency.</li> <li>The specification now features extensive internal referencing, cross-linking and tooltips (aka 'Hover text') to improve navigation and context.</li> </ul>	

## §3. Glossary

### §3.1 Terms

Term/abbreviation	English	Nederlands	Explanation
<b>Artifact</b>		Artefact	(SAML) Pointer to <a href="#">SAML</a> message that is send through the front-channel, to avoid exposing sensitive data to the Webbrowser ( <a href="#">UA</a> ) of the <a href="#">EU</a> .
<b>Assertion</b>		Verklaring	A signed statement about a user's identity and mandates made by an <a href="#">AD</a> or <a href="#">BVD</a> . See <a href="#">SAML Assertion message</a> .
<b>Back channel</b>	Back channel		Receiver ( <a href="#">DV</a> , <a href="#">LC</a> , <a href="#">RD</a> ) uses an Artifact to collect the actual SAML message from the Sender ( <a href="#">RD</a> , <a href="#">AD</a> or <a href="#">BVD</a> ). All SAML Back channel messages are placed in a SOAP envelope, the Webbrowser ( <a href="#">UA</a> ) of the EndUser ( <a href="#">EU</a> ) is not involved.
<b>Front channel</b>	Front channel		Communication between <a href="#">DV</a> , <a href="#">LC</a> , <a href="#">RD</a> , <a href="#">AD</a> and <a href="#">BVD</a> via (a browser redirect of) the Webbrowser ( <a href="#">UA</a> ) of the EndUser ( <a href="#">EU</a> ).
<b>BVD-DDM</b>		Bevoegdheidsverklaringsdienst <a href="#">DigiD-Machtigen</a>	A public instance of <a href="#">BVD</a> specifically for mandates registered in DigiD-Machtigen only for public <a href="#">DV</a>
<b>BVD-OG</b>		BevoegdheidsVerklaringsDienst Ouderlijk Gezag	A public instance of <a href="#">BVD</a> specifically for legal representation concerning parental authority, based on Dutch national database of personal information (maintained by municipalities)
<b>DigiD</b>		DigiD	public IdP ( <a href="#">AD</a> ) only for public <a href="#">DV</a>
<b>DigiD-Machtigen</b>	DDM	DigiD-Machtigen	- public Mandate Registry. See also <a href="#">BVD-DDM</a>
<b>DigiD-CC</b>		DigiD CombiConnect	See also <a href="#">DigiD CC1.1 interface specification</a> .
<b>EntityID</b>			All systems in the network are identified by a unique <a href="#">EntityId in SAML Metadata</a> , which is specified in the SAML metadata
<b>ETD</b>	Trust Framework	Afsprakenstelsel Elektronische Toegangsdiensten	Dutch Trust Framework, also known as 'eHerkenning'. See <a href="https://afsprakenstelsel.etoegang.nl/">https://afsprakenstelsel.etoegang.nl/</a> .

Term/abbreviation	English	Nederlands	Explanation
<b>Legal Representation</b>		Wettelijke Vertegenwoordiging	Legal Representation means that someone ( <a href="#">EU</a> ) is allowed by law to act on behalf of another person ( <a href="#">Represented Party</a> ).
<b>LoA</b>	Level of Assurance	Betrouwbaarheidsniveau	See supported <a href="#">Level of Assurance</a>
<b>Metadata</b>	Metadata		Before a <a href="#">SAML</a> connection can be established, all parties ( <a href="#">DV</a> , <a href="#">LC</a> , <a href="#">RD</a> , <a href="#">AD</a> and <a href="#">BVD</a> ) must exchange connection properties. This is done through SAML Metadata.
<b>Participant</b>		Deelnemer	Any party that has a role in the authentication or representation processes that are within the scope of this specification. These include <a href="#">RD</a> , <a href="#">AD</a> and <a href="#">BVD</a> .
<b>Represented Party</b>		Vertegenwoordigde	<a href="#">Service Consumer</a> represented by <a href="#">EU</a>
<b>SAML</b>	SAML		De SAML v 2.0 standard, also referred to as SAML 2.0. SAML is an acronym of Security Assertion Markup Language. See [ <a href="#">SAML2.TO</a> ].
<b>Service</b>	Service	Dienst	Service offered by a <a href="#">DV</a>
<b>Service Catalog</b>	Service Catalog	Dienstencatalogus of DC	Collection of Services offered by all Service Providers, kept by <a href="#">RD</a> . The <a href="#">DV</a> is responsible for keeping their Services in the Service Catalog up to date.
<b>Service Consumer</b>	Service Consumer	Belanghebbende	Service Consumer is the Entity Concerned: either <a href="#">EU</a> when acting on its own behalf, or the <a href="#">Represented Party</a> when <a href="#">EU</a> is representing someone else.
<b>ServiceUUID</b>		Service Universally Unique Identifier	ServiceUUID is an identifier of a service that is unique in the context of the network
<b>SSO</b>	Single Sign On	Eenmalig Inloggen	
<b>SLO</b>	Single Log Off	Federatief uitloggen	Single Log Off feature
<b>ST-SAML</b>		SAML specification for <a href="#">DV</a> connecting via <a href="#">TVS</a> ( <a href="#">RD</a> ) to <a href="#">DigiD</a> , <a href="#">DigiD-Machtigen</a> and <a href="#">BVD-OG</a>	SAML specification for a <a href="#">DV</a> connecting via <a href="#">TVS</a> (as <a href="#">RD</a> ) to <a href="#">DigiD</a> , <a href="#">DigiD-Machtigen</a> and <a href="#">BVD-OG</a>
<b>TVS</b>	TVS	TVS	public <a href="#">RD</a> only for public <a href="#">DV</a>

### §3.2 Roles

The following roles are used in this specification.

Abbreviation	Role/Actor	Description	Example
<b>AD</b>	Authenticatiedienst	Identity Provider (IdP)	<a href="#">DigiD</a> , <a href="#">EB</a> and <a href="#">AD</a> in <a href="#">ETD</a>
<b>BVD</b>	Bevoegdheidsverklaringdienst	Service that provides assertions for representation relationships	The <a href="#">BVD-DDM</a> ( <a href="#">DigiD Machtigen</a> ), <a href="#">BVD-OG</a> (parental authority)
<b>DV</b>	Dienstverlener	Service Provider	Website of municipality, hospital, government agency
<b>EB</b>	eIDAS Berichten Service	eIDAS Nederland knooppunt	

Abbreviation	Role/Actor	Description	Example
<b>EU</b>	EindGebruiker	End User	Natural Person acting on its own behalf to consume a <a href="#">Service</a> OR acting on behalf of someone else (the <a href="#">Service Consumer</a> ).
<b>LC</b>	Leverancier Clusteraansluiting	Clusterconnection provider: This role assists the <a href="#">DV</a> in connecting to <a href="#">RD</a> . <a href="#">LC</a> will handle all connectivity to <a href="#">RD</a> for their registered <a href="#">DV</a>	PaaS/SaaS providers within the health-care field
<b>RD</b>	Routeringsdienst	Routing Service Provides access to <a href="#">ADs</a> and <a href="#">BVDs</a>	TVS
<b>UA</b>	User Agent	User Agent is application controlled by the <a href="#">EU</a>	WebBrowser

## §4. Introduction

This [ST-SAML](#) specification facilitates Stelsel Toegang release 1. [[ST-SAML1.0](#)] derived from [[eID SAML4.4](#)] and [[eID SAML4.5](#)]. It introduces the [BVD-OG](#) for an extra representation use case: legal representation of a minor by someone with parental authority (Ouderlijk Gezag). If a [DV](#) supports this use case, the [RD](#) (or [DV](#)) will offer the choice to do so to the [EU](#).

[ST-SAML](#) specifies the communication between [DV](#) and [RD](#) and also between [LC](#) and [RD](#). [ST-SAML](#) also specifies the communication between Routeringsdienst ([RD](#)) and [BVD](#) for parental authority ([BVD-OG](#)). [[eID SAML4.5](#)] specifies the communication between [RD](#) and DigiD (as [AD](#)) and between [RD](#) and [BVD](#) for registered mandates in DigiD-Machtigen: [BVD-DDM](#). These DigiD specific specifications are out of scope for this [ST-SAML](#) specification.

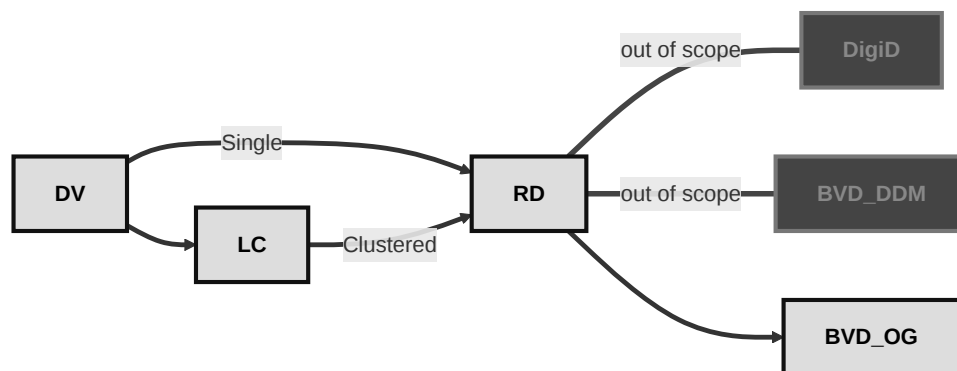

Figure 1 Stelsel Toegang SAML1.0

Routeringsdienst ([RD](#)) supports the use cases summarized below:

Use case	Description
Authentication	Authenticating an <a href="#">EU</a> for a single <a href="#">Service</a> , for a single purpose. This is the most basic use case scenario from a <a href="#">DV</a> 's point of view. Authentication always implies consent of the <a href="#">EU</a> for accessing the <a href="#">Service</a> and may include authorization if the <a href="#">EU</a> is using representation.
Cluster connection connectivity	In a Cluster connection setting, a <a href="#">LC</a> is technically responsible for connecting a <a href="#">DV</a> to <a href="#">RD</a> .
Authentication with representation	an <a href="#">EU</a> authenticates with the intent to consume the <a href="#">Service</a> on behalf of another person <a href="#">Represented Party</a> using a Representation Relationship that is registered within a <a href="#">BVD</a> context.
Authentication and/or representation via a <a href="#">RD</a>	At a <a href="#">RD</a> , an <a href="#">EU</a> interactively selects an <a href="#">AD</a> for which they own an authentication means, and/or a <a href="#">BVD</a> in which a representation relation that they intend to use is registered, from multiple options. The <a href="#">RD</a> redirects the <a href="#">EU</a> to the selected <a href="#">AD</a> and/or <a href="#">BVD</a> .

Use case	Description
Authentication with <a href="#">AD/BVD</a> preselection	Authenticating an <a href="#">EU</a> where selection for the <a href="#">AD</a> or <a href="#">BVD</a> is done at the <a href="#">DV</a> prior to the authentication request to the <a href="#">RD</a> in order to optimize the <a href="#">EU</a> experience.

## § SAML specification

The document is not a complete [SAML](#) reference. It is assumed that the reader is familiar with SAML and will use the referenced documentation as well when needed.

- SAML Message specification - Contains message definitions of all interactions between [DV/LC](#) – [RD](#) and between [RD](#) – [AD/BVD](#).
- SAML Metadata - Contains metadata definitions for [DV](#), [LC](#), [RD](#), [AD](#) and [BVD](#).

## §5. Frameworks

### §5.1 SAML generic

SAML Assertions and Protocols for the OASIS Security Assertion Markup Language (SAML) V2.0 [[SAML2](#)]

- saml-core-2.0-os [[SAML2.CORE](#)]
- saml-profiles-2.0-os [[SAML2.PROFILES](#)]
- saml-metadata-2.0-os [[SAML2.METADATA](#)]
- saml-bindings-2.0-os [[SAML2.BINDINGS](#)]
- saml errata [[SAML2.ERRATA.05](#)]

NORA, Nederlandse Overheid Referentie Architectuur [[NORA](#)].

NCSC ICT-beveiligingsrichtlijnen voor Transport Layer Security (TLS) [[NCSC.TLS](#)].

**SAML profiles** A SAML profile is a specific set of rules that are used for a specific use case. [ST-SAML](#) uses two profiles of the SAML standard, namely:

- Web Browser SSO Profile ([[SAML2.PROFILES](#)], par 4.1), with HTTP Post binding (see below).
- Single Logout Profile ([[SAML2.PROFILES](#)], par 4.4), with HTTP Post binding, issued by Session Participant to Identity Provider.

### §5.2 [DV](#) - SAML message flows & bindings

Only the bindings that are listed in the tables are supported between [DV](#) and [LC](#)

#### § 5.2.1 [DV](#) → [RD](#) authentication flow

The diagram below depicts the authentication flow between a [DV](#) and [LC](#) and the [RD](#).

See also [DV-RD - SAML authentication messages](#)

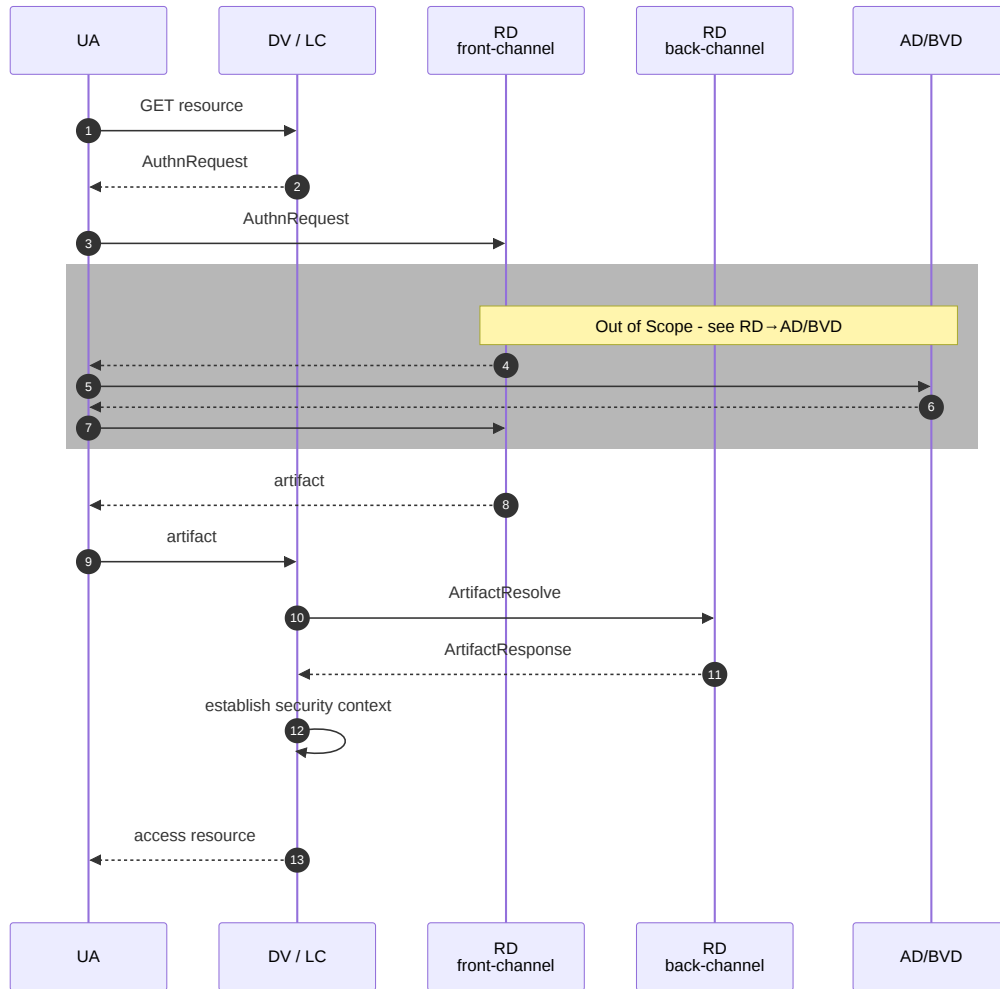

Figure 2 Authentication and representation flow - overview

§ 5.2.1.1 Front-channel (re)authentication

Step #	Route	Message	Endpoint	Binding	Metadata
2 + 3	<u>DV/LC</u> (→ <u>UA</u> ) → <u>RD</u>	<u>AuthN Request message</u>	<u>SingleSignOnService</u>	HTTP-POST	<u>RD → DV</u>
8 + 9	<u>RD</u> (→ <u>UA</u> ) → <u>DV/LC</u>	<u>Artifact binding message</u>	<u>AssertionConsumerService (DV)</u> <u>AssertionConsumerService (LC)</u>	HTTP-Artifact	<u>DV → RD</u> <u>LC → RD</u>

§ 5.2.1.2 Back-channel (Assertion)

Step #	Route	Message	Endpoint	Binding	Metadata
10	<u>DV/LC</u> → <u>RD</u>	<u>Artifact Resolve message</u>	<u>ArtifactResolutionService</u>	SOAP	<u>RD → DV</u>
11	<u>RD</u> → <u>DV/LC</u>	<u>AuthN Response message</u>	None, is a synchronous response	SOAP	

§ 5.2.2 DV → RD Federated Logout flow

Only a limited form of SP (DV/LC) initiated logout is supported within the context of a SSO federation. IdP (AD) initiated Logout is NOT supported! On receiving a logout request from the EU via the UA (step 1) a DV/LC which participates in a SSO federation *MUST* send a LogoutRequest to RD (step 2 and 3). RD propagates the Logout Request to appropriate AD. If the AD replies success status, the RD will reply with a LogoutResponse with success status to the DV/LC.

The diagram below depicts the single logout flow between a DV and LC and the RD.

Also see [SAML Federated login and logout](#)

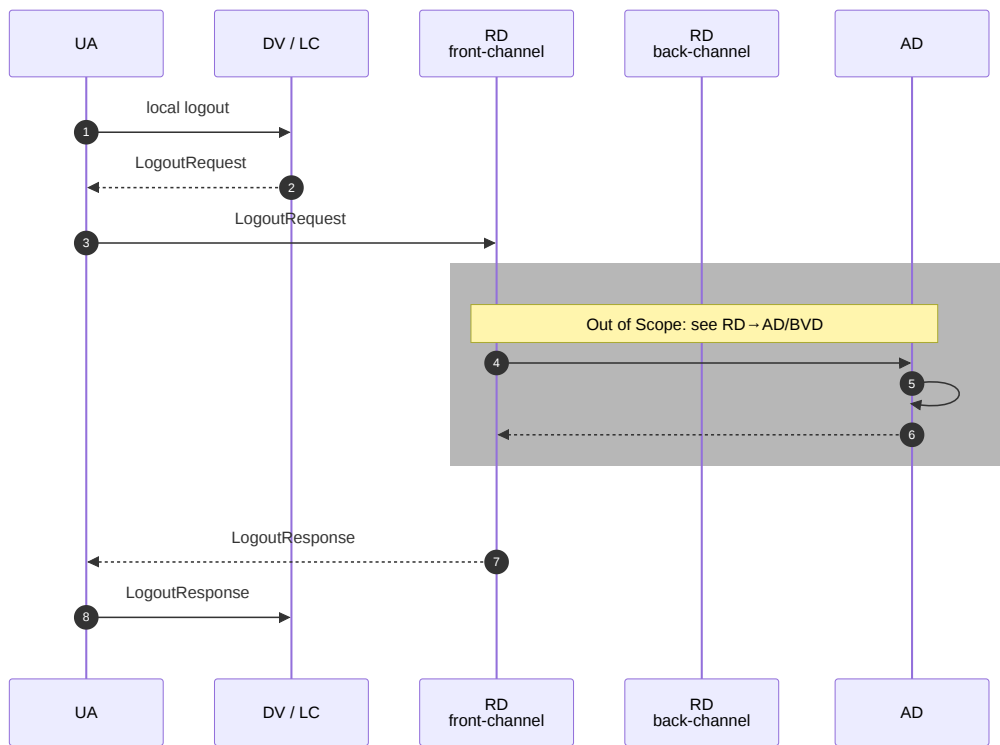

Figure 3 SAML Federated Logout overview

Step #	Route	Message	Endpoint	Binding	Meta-data
2 + 3	<a href="#">DV/LC</a> (→ <a href="#">UA</a> ) → <a href="#">RD</a>	<a href="#">Logout Request</a>	<a href="#">SingleLogoutService</a>	HTTP-POST	<a href="#">RD → DV</a>
7 + 8	<a href="#">RD</a> (→ <a href="#">UA</a> ) → <a href="#">DV/LC</a>	<a href="#">Logout Response</a>	<a href="#">SingleLogoutService</a> (DV) <a href="#">SingleLogoutService</a> (LC)	HTTP-POST	<a href="#">DV → RD</a> <a href="#">LC → RD</a>

### § 5.3 [RD](#) - SAML message flows & bindings

Only the bindings that are listed in the tables are supported between [RD](#) and [AD/BVD](#)

#### § 5.3.1 [RD](#) → [AD](#) authentication flow

A [RD](#) helps the acting End User ([EU](#)) to select the authentication scenario based on registration at the [Service](#) in the [Service Catalog](#). Based on the [EU](#) choices [RD](#) *MUST* propagate the authentication request of the [DV](#) or [LC](#) to the appropriate [AD](#) and in case of representation the appropriate [BVD](#) via the bindings that are listed in the tables below.

The diagram below depicts the authentication flow between a [RD](#) and an [AD](#) and [BVD](#).

See also [RD → AD/BVD - SAML authentication proces](#)

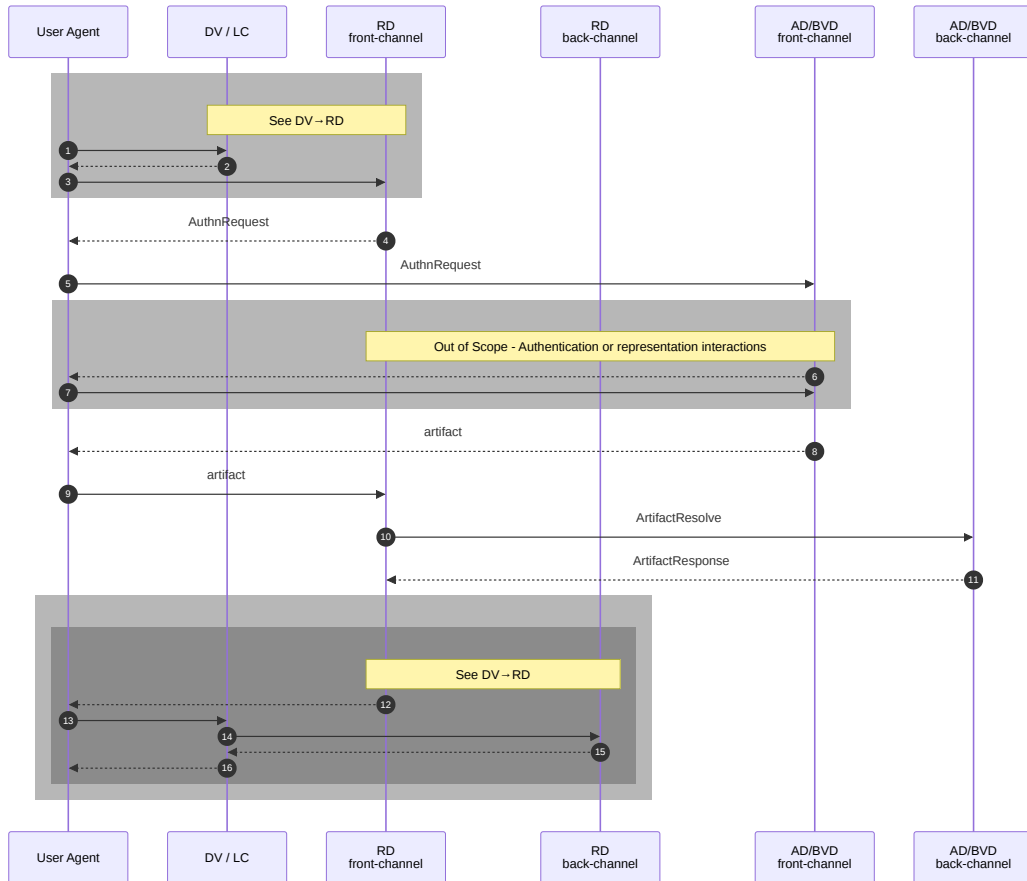

Figure 4 SAML authentication flow RD - AD/BVD

This flow continues between DV and RD, see [DV/LC ← RD - authentication flow](#)

### § 5.3.1.1 Front-channel (re)authentication

Step #	Route	Message	Endpoint	Binding	Meta-data
4 +	<a href="#">RD</a>	<a href="#">AuthN Request</a>	<a href="#">SingleSignOnService</a>	HTTP-	[AD/BVD](#ad-bvd-metadata
5	(→ <a href="#">UA</a> ) → <a href="#">AD/BVD</a>	<a href="#">Message</a>		POST	'AD/BVD metadata for RD)
8 +	<a href="#">AD/BVD</a>	<a href="#">Artifact</a>	<a href="#">AssertionConsumerService</a>	HTTP-	<a href="#">RD</a>
9	(→ <a href="#">UA</a> ) → <a href="#">RD</a>			Artifact	

### § 5.3.1.2 Back-channel (Assertion)

Step #	Route	Message	Endpoint	Binding	Meta-data
10	<a href="#">RD</a> → <a href="#">AD/BVD</a>	<a href="#">Artifact Resolve message</a>	<a href="#">ArtifactResolutionService</a>	SOAP	<a href="#">AD/BVD</a>
11	<a href="#">AD/BVD</a> → <a href="#">RD</a>	<a href="#">ArtifactResponse</a>	None, is a synchronous response	SOAP	

### § 5.3.2 RD - AD Single Logout

A [RD](#) that supports [SSO](#) to [DVs](#) or [LCs](#) must propagate logout requests to the appropriate [RD](#). The diagram below depicts the flow between a [RD](#) and an [AD](#).

See also [RD → AD/BVD Federated login & logout](#)

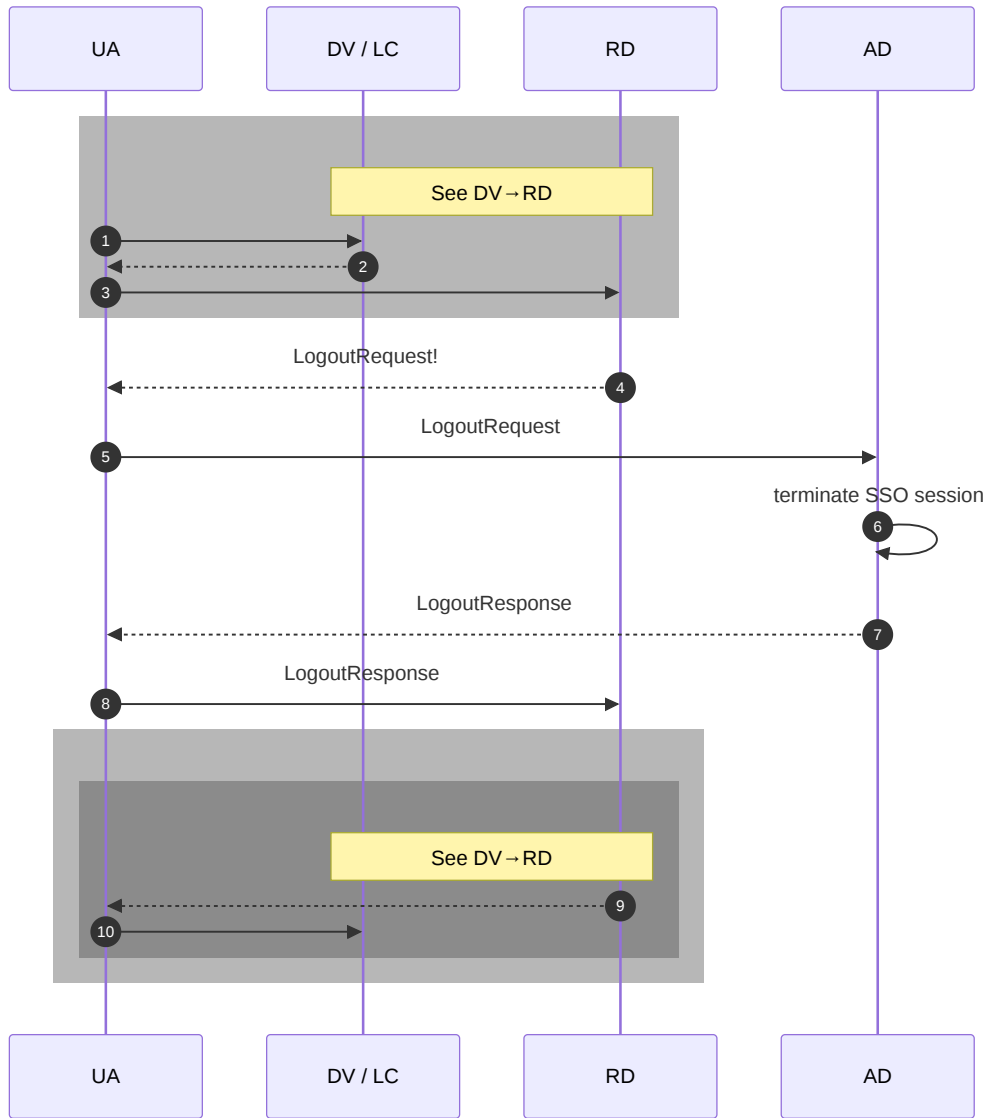

Figure 5 Single Logout RD - AD/BVD

This flow continues between DV and RD, see [DV/LC ← RD - authentication flow](#)

Step #	Route	Message	Endpoint	Binding	Meta-data
4 + 5	<a href="#">RD</a> (→ <a href="#">UA</a> ) → <a href="#">AD</a>	<a href="#">Logout Request</a>	<a href="#">SingleLogoutService</a>	HTTP-POST	<a href="#">AD/BVD</a>
7 + 8	<a href="#">AD/BVD</a> (→ <a href="#">UA</a> ) → <a href="#">RD</a>	<a href="#">Logout Response</a>	<a href="#">SingleLogoutService</a>	HTTP-POST	<a href="#">RD</a>

## §6. Supported Use Cases

### §6.1 Authentication

An [EU](#) intends to consume a Service on his/her own behalf, from a DV for which authentication is required.

#### § 6.1.1 Actors

Roles

- [EU](#)

- [DV](#)
- [RD](#)
- [AD](#)

For more information see also [Roles](#)

### § 6.1.2 Functional description

An [EU](#) intends to consume a [Service](#) on his/her own behalf. The Service is offered on the web by a [DV](#).

The [EU](#) visits the website of the Service, where the [EU](#) may have to interact to indicate the intent to consume the Service. As the Service requires authentication, this triggers the authentication process.

The DV will now redirect the [EU](#) to [RD](#), requesting authentication of the [EU](#) for the [Service](#). Note that in this use case the [EU](#) will not select to act on behalf of another. (See [Authentication with Representation](#))

Next, the [EU](#) is redirected to the [AD](#). After successful authentication the AD takes care the [EU](#) is redirected back to [RD](#), who includes the attestation of identity in the relevant interface response to the DV. This response includes at minimum an identifier of the [EU](#), the [LoA](#) attested to and the [Service](#) authenticated for. The [LoA](#) of the authentication is at minimum equal to or higher than the configured [LoA](#) for the [Service](#) within the [Service Catalog](#). The [RD](#) now includes the attestation of identity and the attestation of representation relationship in the relevant interface response to the [DV](#). This response includes at minimum an identifier of the [EU](#) and the [Represented Party](#), the [LoA](#) attested to and the [Service](#) authenticated for.

The [DV](#) can now take an access control decision to its [Service](#) for the [EU](#).

The technical steps in the authentication flow are described in [DV SAML Authentication](#).

#### NOTE

Communication between [RD](#) and [DigiD](#) is specified in DigiD Combiconnect specification ([DigiD-CC](#)) and is out of scope of this specification.

## §6.2 Authentication with representation

An acting [EU](#) intends to consume a [Service](#) to represent another party, from a [DV](#), for which authentication is required. The [EU](#) acting on behalf of a [Represented Party](#), must be a Natural Person, using a representation relationship. The [Represented Party](#) must also be a Natural Person. The relationship must be formalized and a direct relationship.

The authentication of the acting [EU](#) takes place just like in the Authentication use case. Similarly, the representation information concerning both the acting [EU](#), the [Represented Party](#) and the [Service](#) for which they have a representation relation will provided by a [BVD](#), either

1. Standard representation aka [DigiD-Machtigen](#) by [BVD-DDM](#)
2. Legal representation by other [BVDs](#) eg. [BVD-OG](#).

### § 6.2.1 standard representation

The acting [EU](#) acts on behalf of the [Represented Party](#) ([Service Consumer](#)). The representation relationship underpinning this must be registered by [Represented Party](#) as a formalized mandate in a mandate registry ([DigiD-Machtigen](#)), prior to application in this use case.

Rules governing representation and registration of a registration relationship are out of scope of this specification. Communication between [RD](#) and [BVD-DDM](#) is specified in [DigiD-CC](#) specification and is out of scope of this specification.

## § 6.2.2 legal representation

The information about the [type of legal representation](#) concerning the [EU](#) and the [Represented Party](#) will be provided by a [BVD](#), eg [BVD-OG](#) for parental authority. To make this use case succeed, the relationship between the [EU](#) and the [Represented Party](#) must be registered in the applicable registry in such a way that it meets the legal requirements.

Rules on governing legal representation are out of scope of this specification.

## § 6.2.3 Actors

Roles

- [EU](#)
- [DV](#)
- [RD](#)
- [AD](#)
- [BVD](#)

## § 6.2.4 Functional description

The [EU](#) visits the website of the [Service](#), where the [EU](#) may have to interact to indicate the intent to consume the [Service](#). As the [Service](#) requires authentication, this triggers the authentication process. The [EU](#) must be able to indicate the intent to consume the [Service](#) on behalf of a [Represented Party](#) (and not for his/herself) before the authentication process is triggered.

The [DV](#) (or [LC](#)) will now redirect the [EU](#) to [RD](#), requesting authentication of the [EU](#) for the [Service](#), including the request to authorize based on a representation relationship.

Next, the [EU](#) is redirected to the [AD](#). After successful authentication, the [AD](#) redirects the [EU](#) to [RD](#). [RD](#) will then redirect the [EU](#) to [BVD-DDM](#). Here the [EU](#) selects the representation relationship to use, if multiple options are available. Afterwards the [BVD](#) redirects the [EU](#) back to [RD](#).

[RD](#) now includes the attestation of identity and the attestation of the representation relationship in the relevant interface response to the [DV](#) (or [LC](#)). This response includes an identifier of the [EU](#) and the [Represented Party](#) and in case of legal representation also the specific [type of legal representation](#) between both. Also the requested [ServiceUUID](#) and the [LoA](#) of the authentication is included in the response. The [LoA](#) is at minimum equal to or higher than the configured [LoA](#) for the [Service](#) within the [Service Catalog](#).

The [DV](#) can now take an access control decision to its [Service](#) for the [EU](#) on behalf of the [Represented Party](#).

The technical steps in the authentication flow are described here: [DV SAML Authentication](#).

## §6.3 Cluster connection connectivity

In Software-as-a-Service ([SaaS](#)) or multi-tenant solutions, multiple [DV](#)'s are hosted on a single environment operated by a software vendor. The software vendor can act as an [LC](#). Functionally the [LC](#) itself is not actively taking part in any of the primary use cases, thus is not an actor in those use cases.

NOTE

Although above the Cluster is linked to SaaS solutions, the cluster connection can be applicable in Platform-as-a-Service (PaaS) offerings as well. This is only the case if the platform natively offers connectivity to [RD](#); it is NOT applicable if the connectivity is built on top of the platform provided using PaaS.

For Infrastructure-as-a-Service solutions (IaaS), the Cluster Connection is NOT applicable.

§ 6.3.1 Actors

Roles	Description
<a href="#">DV</a>	See also <a href="#">Roles</a>
<a href="#">LC</a>	
<a href="#">RD</a>	

§ 6.3.2 Technical description

The Cluster Connection is acknowledged during requests for authentication, as made in the supported use cases. The [LC](#) is registered at [RD](#) and is also responsible for registering all [DV](#)'s he provides access for. Relationship between [DV](#) and [LC](#) must be established in the registration/on-boarding process with [RD](#) and in [LC](#)-metadata.

[DV](#) initiates authentication via the [LC](#). The [LC](#) will send an [AuthN Request Message](#) to [RD](#) on behalf of [DV](#).

Data in the response from [RD](#) will be encrypted only for the [DV](#) to decrypt, not the [LC](#).

In this way, the [LC](#) can facilitate the authentication processes, but cannot access the sensitive information contained in the response.

NOTE

The way a [DV](#) interacts with a [LC](#) is not part of this specification.

§ 6.4 Authentication with AD/BVD preselection

an [EU](#) intends to consume a [Service](#) on his/her own behalf, from a (semi-)governmental or public [DV](#)], for which authentication is required. The [EU](#) makes the selection for the [AD](#) at the [DV](#) , rather than at the [RD](#). In order to improve [=EU=|user] experience (UX), this enables presenting the choice of [AD](#) at the [DV](#) at the most appropriate time and in the best fitting manner.

Additionally in a representation scenario, the [EU](#) can (also) select the [BVD](#) at the [DV](#) .

NOTE

Passing the choice for [AD/BVD](#) is solely offered for improving [=EU=|user] experience. It is explicitly not the intention that [DV](#) introduce a bias in the choice for the [AD/BVD](#) to use. Valid use cases for bypassing [EU](#) preference, where a [DV](#) selects a specific [AD/BVD](#) for an [EU](#) , are very rare and specific. [DV](#) should offer the choice for each [AD/BVD](#) in a non-discriminatory way for all applicable [AD/BVD](#).

§ 6.4.1 Actors

Roles

- [EU](#)

- [DV](#)
- [RD](#)
- [AD](#)
- [BVD](#)

For more information see also [Roles](#)

#### § 6.4.2 Functional description

This use case is a functional extension to Authentication. Instead of choosing the [AD](#) and/or [BVD](#) after being redirected to the [RD](#), the [EU](#) selects the [AD](#) and/or [BVD](#) for usage at an earlier stage at the [DV](#). The [RD](#) will apply the pre-selection as a filter on all available options. If, after filtering, alternative options are found, the [RD](#) will prompt the [EU](#) to further narrow down the selection.

The [DV](#) will offer the [EU](#) to make a choice from the list of applicable [ADs](#) before sending a request for authentication to the [RD](#). Simultaneously with the choice for an [AD](#), the choice to represent another will be offered the [EU](#) with (optionally) the [BVD](#) to be used. After making the choice for an [AD](#), acting-as-a-representative and the choice for a [BVD](#), these choices will be included in the request for authentication to the [RD](#). In case the [EU](#) acts on behalf of another without pre-selecting a [BVD](#), the choice for a [BVD](#) will be presented in a later stage at the [RD](#).

The technical steps in the authentication flow are described in the [SAML-Message-specification](#).

## §7. Message Specification

### §RD - Leeg

#### §7.1 DV - SAML Message specification

##### § 7.1.1 DV → RD - SAML authentication proces

SAML authentication messages between [DV](#) (or [LC](#)) and [RD](#) are described in this chapter. First the authentication overview and the steps, then the specification of the individual SAML messages between [DV](#) and [RD](#).

##### § 7.1.1.1 DV → RD - authentication - diagram

The diagram below contains the authentication steps that are made when an [EU](#) authenticates with a [DV](#) through the [RD](#). When an [LC](#) is present between [DV](#) and [RD](#) the [LC](#) will take the role of [DV](#) in relation to the [RD](#).

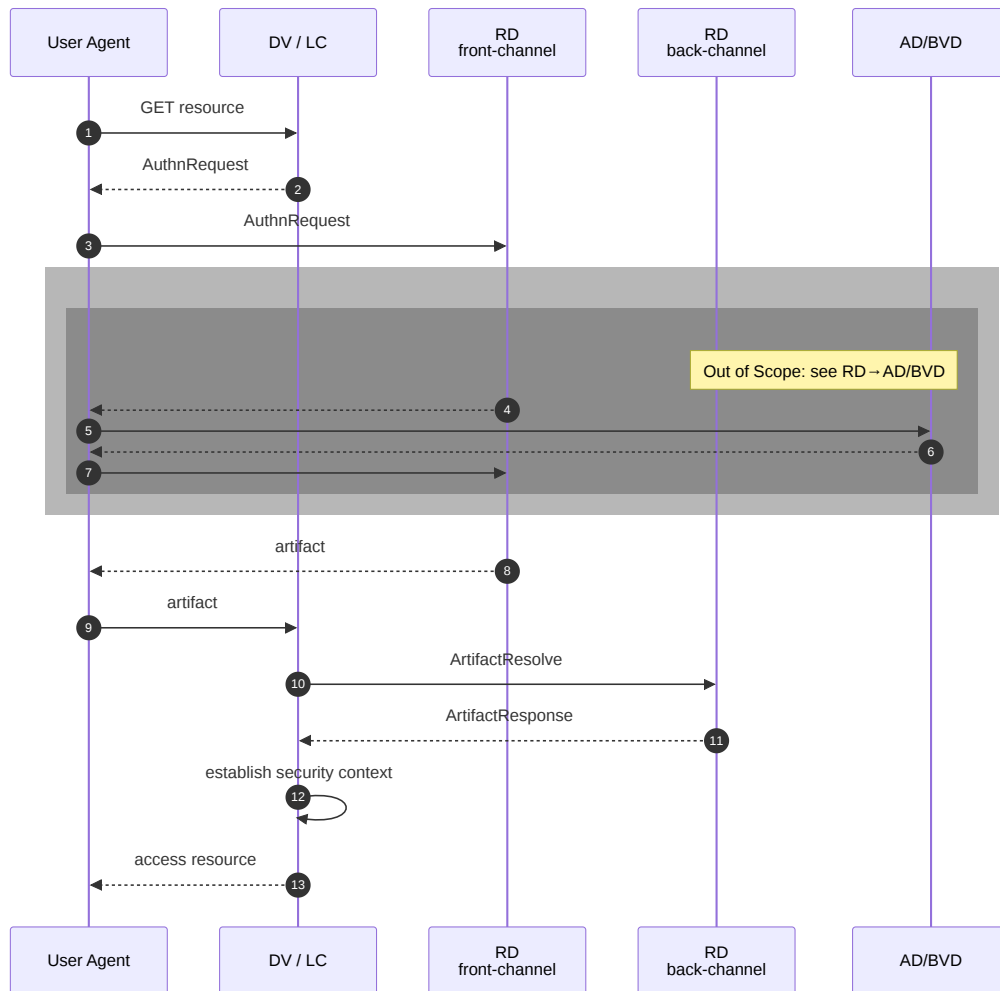

Figure 6 SAML authentication flow - DV/LC - RD

§ 7.1.1.2 DV → RD - authentication - steps

Before the above authentication steps are explained, it is important to make a distinction between the [Front channel](#) and the [Back channel](#). The [Front channel](#) is the communication between the [DV](#) or [LC](#) and [RD](#) via the [UA](#) of the [EU](#) (step 2 & 3 and step 8 & 9 in the figure above). The [Back channel](#) is the direct communication between the [DV](#) or [LC](#) and [RD](#) (step 10 and Step 11 in the figure above). This distinction is important because possibly sensitive data (such as a citizen service number) is never send via the [Front channel](#), so that they can never be intercepted or changed by the [UA](#).

**Step 1**

The [EU](#) with a [UA](#) wants to access a part on the web service of the [DV](#) that requires authentication of the [EU](#).

**Step 2 and 3**

The [DV](#) or [LC](#) will send the [EU](#) to [RD](#) for authentication and or proof of representation.

**Step 4 up to and including 7 (out of scope for this flow)**

In this step the [RD](#) will offer the [EU](#) a choice of [AD](#)'s and [BVD](#)'s that fulfil the authentication requirements (e.g. minimum level of assurance required, type of mandate). Optionally, the [DV](#) can pass pre-selection information concerning the [AD](#) to query, and if representation will be used, to the [RD](#).

If the [EU](#) hasn't already chosen in step 2, the [EU](#) chooses an authentication method that meets the minimum required [LoA](#), and also chooses whether to use representation. The [EU](#) is presented with the corresponding [AD](#) login screen. The [EU](#) authenticates with the chosen means.

Optionally, the [EU](#) also chooses a representation method. The [EU](#) is presented with the corresponding screen with choice of who to represent. The [EU](#) chooses the correct [Represented Party](#) to represent.

#### Step 8 and 9

[RD](#) sends the [EU](#) back to the [DV](#) or [LC](#) via a redirect. An opaque [Artifact](#) generated by [RD](#) is send here. This [Artifact](#) refers to the actual [Artifact Response message](#) that is waiting at [RD](#).

Even if the authentication starting in step 4 was unsuccessful or interrupted, an artifact is send to the [DV](#) or [LC](#). This [Artifact](#) provides an error message with the [Artifact Resolve request](#) and cannot be exchanged for a valid [Assertion](#).

#### Step 10

With the [Artifact](#) the [DV/LC](#) sends an [Artifact Resolve request](#) to the [RD](#) for the result of the (successful or unsuccessful) authentication and (optionally) representation via a [Back channel](#).

Artifacts are stored by [RD](#) for a maximum of 15 minutes and can only be retrieved once by the [DV/LC](#). Situations are possible (process breakdown, early logout) where [RD](#) saves an [Artifact](#) for less than 15 minutes.

#### Step 11

[RD](#) replies with an [Artifact Response message](#) that belongs to the [Artifact](#). In this message, [RD](#) provides an [Assertion](#) that includes the authentication result and optionally the representation selection. And, if the authentication / representation selection was successful, the requested (encrypted) identifier(s) and attribute(s) of the [EU](#) and optionally the [Represented Party](#). The identities and attributes are encrypted so that only the intended [DV\(s\)](#) can obtain the plain text value.

If the authentication or attempt to select representation was unsuccessful, it is indicated in the Status Code of the Response message and if possible, a reason is given so that the web service can inform the [EU](#).

#### Step 12 & 13

Successful authentication / selection of representation gives the [DV](#) information needed for access control decision typically resulting in [EU](#) access to service in step 13.

### § 7.1.2 DV → RD - SAML messages

The SAML messages are specified in detail in the following sections. The following rules apply

1. The messages contain at least the elements that are specified as mandatory by the standard.
2. In addition, the messages also contain optional elements. It is indicated whether these elements are mandatory, conditional or optional. With optional elements, it is up to the participants to determine whether they are used.
3. Optional SAML elements that are not in this specification *SHOULD NOT* be included. When present they will be ignored when possible.

#### § 7.1.2.1 DV → RD AuthnRequest

When a principal (or an agent acting on the principal's behalf) wishes to obtain assertions containing authentication statements to establish a security context at one or more relying parties, it can use the authentication request protocol to send an [AuthN Request message](#) message element to a SAML authority and request that it returns a [AuthN-Response message](#) containing one or more such assertions.

##### § 7.1.2.1.1 DV → RD AUTHNREQUEST DIAGRAM

The possible sender and recipient of the AuthnRequest message are the following:

**Sender Recipient**

DV    RD

LC    RD

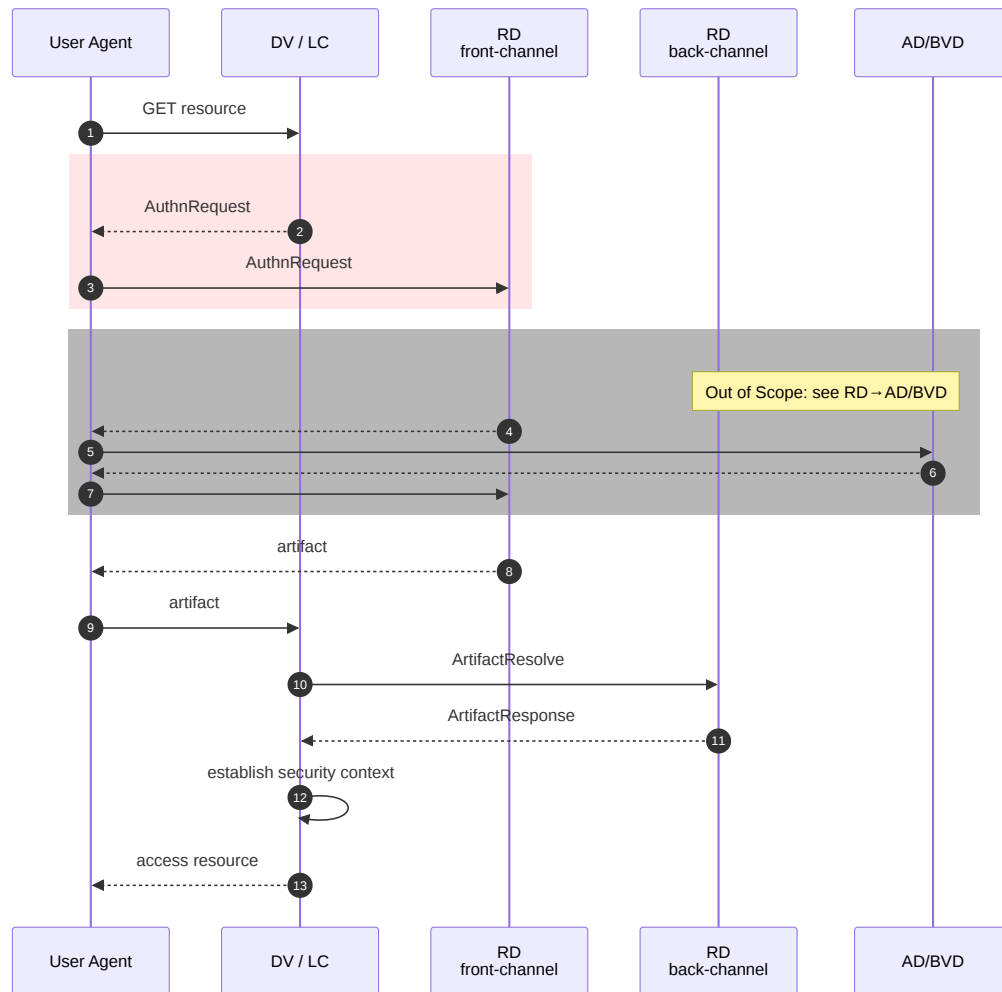

Figure 7 SAML authentication flow - DV/LC - RD - AuthN-Request

§ 7.1.2.1.2 DV → RD AUTHNREQUEST MESSAGE

See also [Example AuthnRequest DV for RD](#)

Element/@Attribute	0..n	Description
		<b>Issuer = DV or LC</b> <b>Recipient = RD</b>
@ID	1	Unique message identifier. <i>MUST</i> identify the message uniquely within the scope of the sender and receiver for a period of at least 12 months.
@Version	1	Version of the SAML protocol. The value <i>MUST</i> be 2.0.
@IssueInstant	1	Time of issuing of the request.
@Destination	1	URL of the recipient on which the message is offered. <i>MUST</i> match <a href="#">SingleSignOnService</a> in the metadata .
@ForceAuthn	0..1	The value <code>true</code> indicates that an existing <a href="#">SSO</a> session <i>MUST NOT</i> be used for the request. If the value is <code>false</code> or empty or the attribute is missing, an existing <a href="#">SSO</a> session <i>MAY</i> be used for the request.

Element/@Attribute	0..n	Description Issuer = DV or LC Recipient = RD
<b>@AssertionConsumerServiceIndex</b>	1	This index <i>MUST</i> refer to an endpoint of an <a href="#">AssertionConsumerService</a> in the issuer's metadata for the recipient.  <i>NOTE: as a consequence, the AssertionConsumerServiceURL MUST NOT be included.</i>
<b>@AttributeConsumingServiceIndex</b>	0..1	Conditional. Only one of <a href="#">Extensions</a> or <a href="#">@AttributeConsumingServiceIndex</a> <i>MUST</i> be present.  <i>NOTE: Also see the use of @AttributeConsumingServiceIndex and Extensions</i>
<b>@ProviderName</b>	0..1	Conditional. Reserved for use with eIDAS UIT to show information about the foreign <a href="#">DV</a> and country in order to obtain <a href="#">EU</a> consent. <i>SHOULD NOT</i> be used in other use cases and will be ignored if used.
<b>Issuer</b>	1	<i>MUST</i> contain the <a href="#">EntityID</a> of the issuer as registered in the <a href="#">Metadata</a> .
<b>Signature</b>	1	<i>MUST</i> contain the XML signature of the sender for the enveloped message. <i>MUST</i> contain a KeyInfo element with a KeyName or X509Certificate elements. See <a href="#">Signature</a>
<b>Extensions</b>	0..1	Conditional. Only one of <a href="#">Extensions</a> or <a href="#">AttributeConsumingServiceIndex</a> <i>MUST</i> be present. And when <a href="#">Extensions</a> is present, it <i>MUST</i> contain the attributes described below.  <i>NOTE: Also see the use of @AttributeConsumingServiceIndex and Extensions</i>
<b>-Attribute</b>	1	An Attribute with the @Name="urn:n1-eid-gdi:1.0:IntendedAudience" <i>MUST</i> be present and contain an AttributeValue with the <a href="#">EntityID</a> of the <a href="#">DV</a> for which authentication is requested.  <i>NOTE: (future) support for more than one audience where each audience receives the audience specific EncryptedID is provided by the Service Definition registered with the Service Catalog.</i>
<b>-Attribute</b>	1	An Attribute with the @Name="urn:n1-eid-gdi:1.0:ServiceUUID" <i>MUST</i> be present and contain an AttributeValue containing a <a href="#">ServiceUUID</a> that is known at the <a href="#">Service Catalog</a> of the receiving <a href="#">RD</a> , <a href="#">AD</a> and <a href="#">BVD</a> .
<b>-Attribute</b>	0..1	Conditional. An Attribute with the @Name="urn:n1-eid-gdi:1.0:IdpAssertion".  <i>NOTE: This attribute MUST NOT be used (for DV → RD and LC → RD). See AuthN-Request differences for rules on using the Attribute with @Name="urn:n1-eid-gdi:1.0:IdpAssertion" for RD → AD/BVD</i>
<b>Scoping</b>	0..1	Conditional. Element <i>MAY</i> be used to limit the selection of <a href="#">AD</a> 's or <a href="#">BVD</a> 's at the <a href="#">RD</a> .  <i>_NOTE: different rules for RD → AD/BVD, see AuthN-Request differences _</i>
<b>-IDPList</b>	0..1	Conditional. List of IDP's - Element <i>MUST</i> be present in DV Authn-request message when Scoping element is present.  <i>NOTE: MUST NOT be used for RD → AD/BVD, see AuthN-Request differences</i>
<b>--IDPEntry</b>	1..n	At least one IDPEntry (of an <a href="#">AD</a> ) <i>MUST</i> be present if the IDPList element is present.  If no valid IDPEntry is present, the AuthnRequest will fail with a top level

Element/@Attribute	0..n	Description
		Issuer = DV or LC Recipient = RD  status code urn:oasis:names:tc:saml:2.0:status:Requester and second-level code depending on the condition according to [SAML2.CORE] section 3.2.2.2: urn:oasis:names:tc:SAML:2.0:status:NoSupportedIDP. If the list also contains the <a href="#">EntityID</a> of a <a href="#">BVD</a> . This indicates that representation using the <a href="#">BVD</a> is optional in combination with the <a href="#">AD</a> (s) in the IDPList. The <a href="#">RD</a> will let the <a href="#">EU</a> choose whether to use representation with a <a href="#">BVD</a> . The <a href="#">RD</a> <i>MUST</i> limit the <a href="#">AD</a> and <a href="#">BVD</a> selection list presented to <a href="#">EU</a> 's for <a href="#">AD</a> 's or combination of <a href="#">AD</a> 's and <a href="#">BVD</a> 's that are supported.
<a href="#">--@ProviderID</a>	1	<i>MUST</i> contain the <a href="#">EntityID</a> of a pre-selected <a href="#">AD</a> or <a href="#">BVD</a>  Conditional. Element <i>MAY</i> be present if using authentication with representation. If used it <i>MUST</i> contain the <a href="#">EntityID</a> of a <a href="#">BVD</a> . If more than one RequesterID is included with different <a href="#">BVD</a> 's the <a href="#">RD</a> <i>MUST</i> let the <a href="#">EU</a> choose a <a href="#">BVD</a> . If both RequesterID and IDPList are used, any <a href="#">BVD</a> that is in a RequesterID <i>MUST</i> also be included in the IDPList.
<a href="#">-RequesterID</a>	0..n	<i>MUST</i> let the <a href="#">EU</a> choose a <a href="#">BVD</a> . If both RequesterID and IDPList are used, any <a href="#">BVD</a> that is in a RequesterID <i>MUST</i> also be included in the IDPList.

*NOTE: different rules for [RD](#) → [AD](#)/[BVD](#), see [AuthN-Request differences](#)*

#### § 7.1.2.1.2.1 THE USE OF [ATTRIBUTECONSUMINGSERVICEINDEX](#) OR [EXTENSIONS](#) FOR REFERRING TO SERVICE DEFINITIONS

This specification uses the concept of a [Service Catalog](#) kept by [RD](#), which contains amongst others [Service Definitions](#). In the [Service Catalog](#) each '[Service Definition](#)' has a unique [ServiceUUID](#). Each [AuthN Request message](#) must refer to a [Service Definition](#) using its [ServiceUUID](#).

An [AuthN Request message](#) has two options for this [ServiceUUID](#) reference:

1. Only the [DV](#) *MAY* provide a [@AttributeConsumingServiceIndex](#) that *MUST* correspond to an [Index](#) attribute of an [AttributeConsumingService](#) entry in the [DV Metadata](#). And this [AttributeConsumingService](#) entry *MUST* contain a [ServiceUUID](#). When using the [AttributeConsumingServiceIndex](#) the [RD](#) will obtain the [DV](#)'s [EntityID](#) from the [Issuer](#) element in the [AuthN Request message](#).
2. Alternatively a [DV](#) *MAY* use the [Extensions](#) element in the [AuthN Request message](#). All other [Participants](#) *MUST* use the [Extensions](#) element in the [AuthN Request message](#). The [Extensions](#) element contains both the [EntityID](#) of the [DV](#) and the explicit [ServiceUUID](#).

#### § 7.1.2.1.3 DV → RD AUTHNREQUEST PROCESSING RULES

In addition to the processing rules required by the SAML specification the following rule applies. If any of these validations fails, the authentication *MUST* fail:

1. [RD](#) *MUST* validate that the [DV](#) is registered for the requested [ServiceUUID](#) referenced by the index in the [DV metadata](#) or in the [Extensions element of the DV AuthN-request](#) and validate that the registration is valid;
2. IF an [LC](#) is involved THEN [RD](#) *MUST* validate that the [DV](#) is registered to use the requested [ServiceUUID](#) with the [LC](#) that sends the [DV AuthN-Request message](#) on behalf of the [DV](#) and that the registration is valid;

#### § 7.1.2.2 DV ← RD Artifact Binding

The SAML response of a [RD](#) to a [SAML request](#) of a [DV](#) (or [LC](#)) uses an [Artifact](#)-Binding for extra security see [SAML2.BINDINGS] section 3.6.6. Therefore SAML Response does not return the actual SAML message with an

Authentication Assertion but an [Artifact](#) as a reference to actual the SAML [AuthN Response - Assertion](#) message. The Artifact is used by the [DV](#) (or [LC](#)) to retrieve the SAML [AuthN Response - Assertion](#) at the [RD](#).

§ 7.1.2.2.1 DV ← RD - ARTIFACT BINDING - DIAGRAM

The sender and recipient of this message are the following:

Sender Recipient	
<a href="#">RD</a>	<a href="#">DV</a>
<a href="#">RD</a>	<a href="#">LC</a>

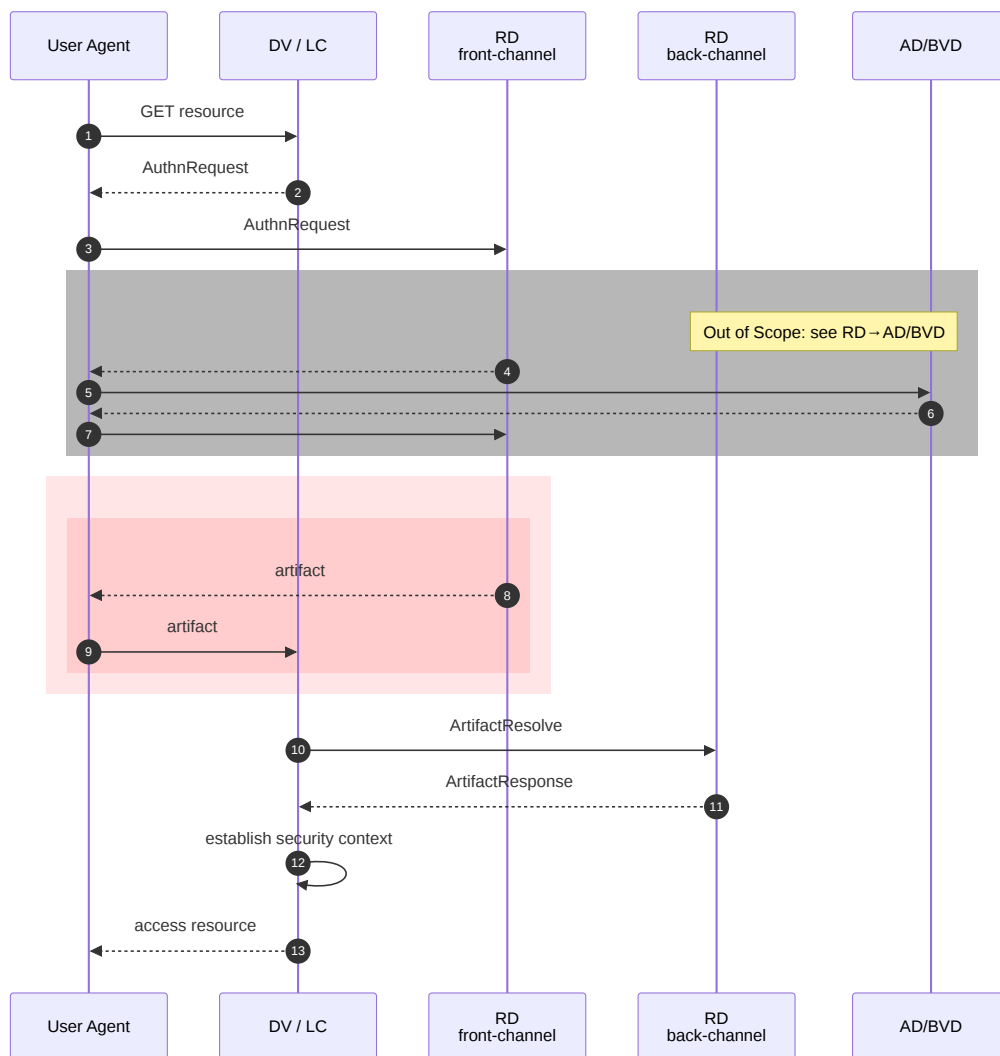

Figure 8 SAML authentication flow - DV/LC - RD - Artifact Response

§ 7.1.2.2.2 DV ← RD - ARTIFACT BINDING - MESSAGE

The [RD](#) sends an [Artifact](#) via the [Front channel](#) to the [DV/LC](#), using a HTTP-redirect of the [webbrowser](#) to the [AssertionConsumerService](#) referenced in the [AuthN Request message](#).

e.g. `https://dv.nl/SAML/ACS?SAMLart=AAQAAMh0dHA6Ly9pZHAuZXhhbXBsZS5jb20vU0FNTC9N&RelayState=xyz123`

The [Artifact](#) is only a reference to the SAML [AuthN Response - Assertion](#). And even if no authentication has taken place, an [Artifact](#) will be send.

§ 7.1.2.3 DV → RD ArtifactResolve

The [DV/LC](#) uses the [Artifact](#) to send an [ArtifactResolve request](#) to the [RD](#) via a SOAP binding over the [Back channel](#). The [Back channel](#) is protected with two-sided TLS authentication.

§ 7.1.2.3.1 DV → RD ARTIFACTRESOLVE DIAGRAM

The sender and recipient of the [Artifact Resolve](#) are the following:

Sender	Recipient
DV	RD
LC	RD

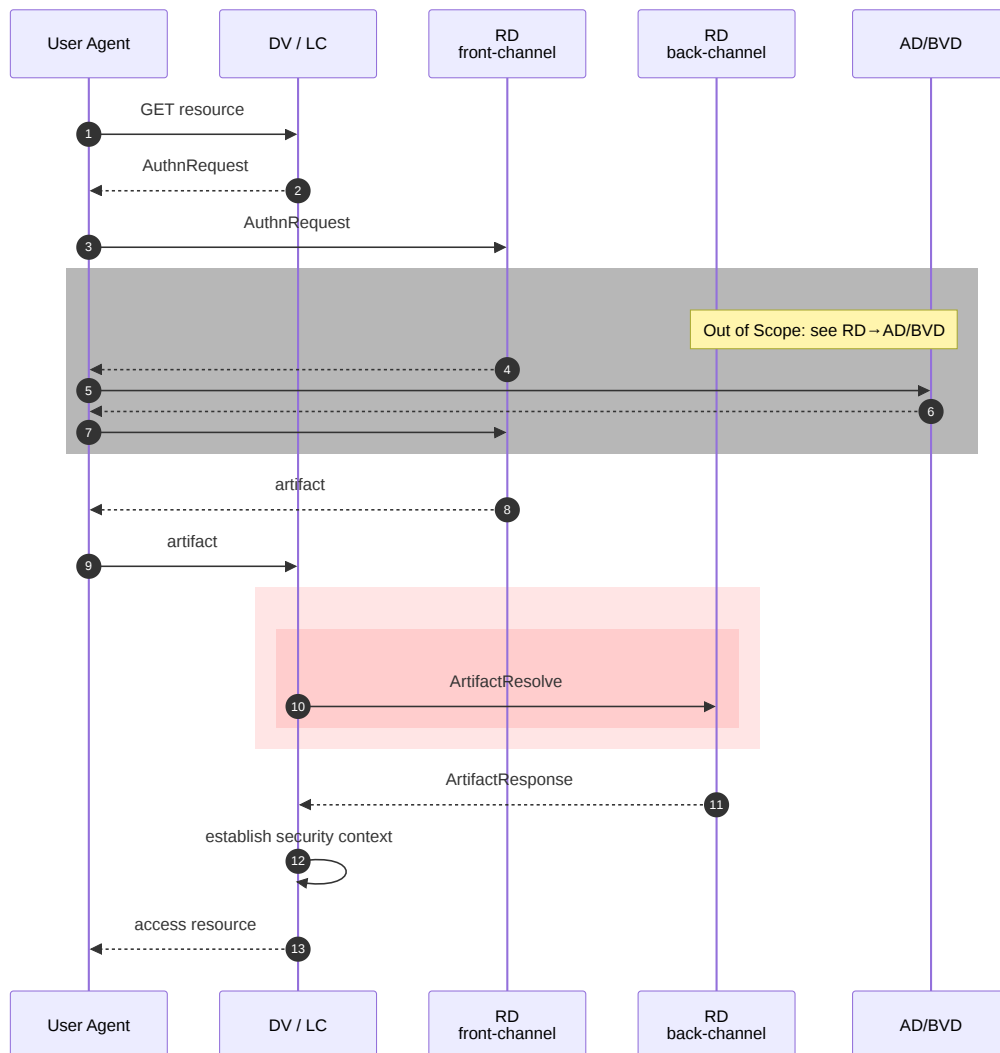

Figure 9 SAML authentication flow - DV/LC - RD - Artifact Resolve

§ 7.1.2.3.2 DV → RD ARTIFACTRESOLVE MESSAGE

Element/@Attribute	0..n	Description
@ID	1	Unique message identifier. <i>MUST</i> identify the message uniquely within the scope of the sender and receiver for a period of at least 12 months.
@Version	1	Version of the SAML protocol. The value <i>MUST</i> be 2.0.
@IssueInstant	1	Time at which the message was created.
@Destination	0..1	<i>MAY</i> be included. If included <i>MUST</i> contain the URL of the receiver on which the message is offered. <i>MUST</i> match one of the <a href="#">ArtifactResolutionService</a> elements in the receiver's metadata.
Issuer	1	<i>MUST</i> contain the <a href="#">EntityID</a> of the sender.
Signature	1	<i>MUST</i> contain the Digital signature of the sender for the enveloped message. <i>MUST</i> contain a KeyInfo element with either a KeyName or X509Certificate elements. See <a href="#">Signature</a> .
Artifact	1	Contains the <a href="#">Artifact</a> that was received as query parameter.

§ 7.1.2.4 DV ← RD ArtifactResponse

In response to the [Artifact Resolve message](#), the [RD](#) will send an [Artifact Response message](#) back to the [DV/LC](#) via the SOAP binding over the [Back channel](#). If successful this [Artifact Response message](#) contains the [AuthN-Response Assertion](#) for the original [AuthN Request message](#).

§ 7.1.2.4.1 DV ← RD ARTIFACTRESPONSE DIAGRAM

The sender and recipient of the [Artifact Response message](#) message are the following:

Sender	Recipient
RD	DV
RD	LC

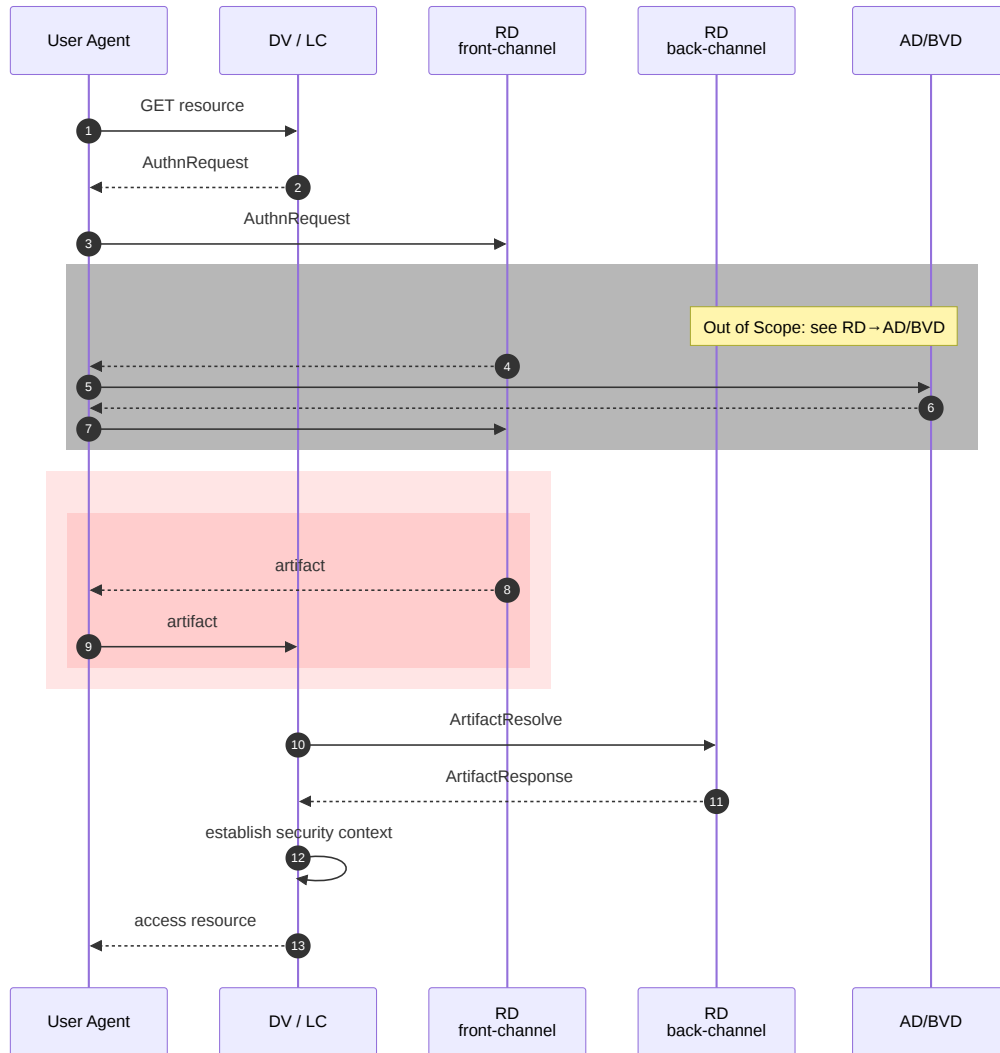

Figure 10 SAML authentication flow - DV/LC - RD - Artifact Response

§ 7.1.2.4.2 DV ← RD ARTIFACTRESPONSE MESSAGE

Element/@Attribute	0..n	Description
@ID	1	Unique message identifier. <i>MUST</i> identify the message uniquely within the scope of the sender and receiver for a period of at least 12 months.
@InResponseTo	1	Unique ID attribute of the <a href="#">Artifact Resolve message</a> request for which this <a href="#">ArtifactResponse message</a> is the response.
@Version	1	Version of the SAML protocol. The value <i>MUST</i> be 2.0.
@IssueInstant	1	Time of issuing of the <a href="#">AuthN Response message</a> .
Issuer	1	<i>MUST</i> contain the <a href="#">EntityID</a> of the sender.
Signature	1	<i>MUST</i> contain the Digital signature of the sender for the enveloping message. <i>MUST</i> contain a KeyInfo element with a KeyName element. See <a href="#">Signature</a> .
Status	1	<i>MUST</i> contain a <a href="#">StatusCode</a> element with the status of the artifact resolve.
-StatusCode	1	<i>MUST</i> be present in a <a href="#">Status</a> element.
-@Value	1	The <a href="#">Value</a> of this <a href="#">StatusCode</a> element <i>MUST</i> be from the top-level list provided in <a href="#">[SAML2.CORE]</a> section 3.2.2.2 and follow the rules described in <a href="#">[SAML2.BINDINGS]</a> section 3.6.6.
--StatusCode	0..1	Conditional. Should only be present if top-level <a href="#">StatusCode</a> is not urn:oasis:names:tc:SAML:2.0:status:Success.

Element/@Attribute	0..n	Description
--@Value	1	If present <i>MUST</i> contain an URI reference indication details about the error.
-StatusMessage	0..1	Only present if top-level <a href="#">StatusCode</a> is not urn:oasis:names:tc:SAML:2.0:status:Success. <i>MAY</i> contain a message detailing the error that occurred.
Response	0..1	Conditional. If the artifact resolves to a response this <i>MUST</i> contain the <a href="#">AuthN Response - Assertion</a> to the <a href="#">AuthN Request message</a> . The <a href="#">AuthN Response - Assertion</a> is described below.

#### § 7.1.2.4.2.1 PROCESSING RULES FOR STATUS

Special processing rules for [Status](#) are described in [[SAML2.BINDINGS](#)] §3.6.6.

Even if the ArtifactResponse's [Status](#) indicates success it may still not contain a [AuthN Response - Assertion](#) conform [[SAML2.BINDINGS](#)] §3.6.6:

If the [RD](#) receives an [Artifact Resolve message](#) message that it can understand, it *MUST* return a [AuthN Response message](#) with a [StatusCode](#) value of urn:oasis:names:tc:SAML:2.0:status:Success`, even if it does not return the corresponding message (for example because the artifact requester is not authorized to receive the message or the artifact is no longer valid).

#### § 7.1.2.4.3 DV ← RD AUTHN RESPONSE - MESSAGE

Via the [Artifact Response Message](#) the [RD](#) sends the [SAML AuthN-Response Message](#) which is the response the original [AuthN Request message](#) of the [DV/LC](#). The [SAML AuthN-Response Message](#) contains the [AuthN Response - Assertion](#) if authentication of the [EU](#) at the [AD](#) was successful, and (when relevant) the [BVD](#) could establish a valid representation relationship.

Element/@Attribute	0..n	Description
@ID	1	Unique message characteristic. <i>MUST</i> identify the message uniquely within the scope of the sender and receiver for a period of at least 12 months.
@InResponseTo	1	Unique <a href="#">ID</a> attribute of the <a href="#">AuthN Request message</a> request for which this <a href="#">AuthN Response - Message</a> is the response.
@Version	1	Version of the SAML protocol. The value <i>MUST</i> be 2.0.
@IssueInstant	1	Time of issuing of the <a href="#">AuthN Response - Assertion</a> .
@Destination		URL of the endpoint on which the message is offered. <i>MUST</i> match a recipient's metadata <a href="#">AssertionConsumerService</a> .
Issuer	1	<i>MUST</i> contain the <a href="#">EntityID</a> of the sender.
Signature	0..1	<i>SHOULD NOT</i> be used as the <a href="#">AuthN Response - Assertion</a> is part of the <a href="#">AuthN Response message</a> messages which is already signed by <a href="#">RD</a> . If included <i>MUST</i> contain the Digital signature of <a href="#">RD</a> for the enveloping message. <i>MUST</i> contain a <a href="#">KeyName</a> or <a href="#">X509Certificate</a> element.
Status	1	<i>MUST</i> contain a <a href="#">StatusCode</a> element with the status of the authentication.
-StatusCode	1	<i>MUST</i> be present in a <a href="#">Status</a> element.
--@Value	1	If not urn:oasis:names:tc:SAML:2.0:status:Success additional information <i>SHOULD</i> be provided in the embedded <a href="#">StatusCode</a> element. The <a href="#">Value</a> of this <a href="#">StatusCode</a> element <i>MUST</i> be from the top-level list provided in SAML core section 3.2.2.2. See the codes listed in Error codes.
--StatusCode	0..1	Conditional. <i>SHOULD</i> only be present if top-level <a href="#">StatusCode</a> is not urn:oasis:names:tc:SAML:2.0:status:Success.
--@Value	1	In the event of a cancellation or error, the element <i>MUST</i> be populated with the value urn:oasis:names:tc:SAML:2.0:status:AuthnFailed.

Element/@Attribute	0..n	Description
<b>-StatusMessage</b>	0..1	Only present if top-level StatusCode is not urn:oasis:names:tc:SAML:2.0:status:Success. <i>MAY</i> contain a message detailing the error that occurred, <i>MUST</i> contain exact phrase Authentication cancelled when authentication is cancelled (see also <a href="#">SAML Error codes</a> )
<b>Assertion</b>	0..1	Conditional. <i>MUST</i> contain the <a href="#">AuthN Response - Assertion</a> if the request was processed successfully (Status was urn:oasis:names:tc:SAML:2.0:status:Success). See <a href="#">AuthN Response - Assertion</a> . Otherwise, <i>MUST</i> not be included.
<b>EncryptedAssertion</b>	0	<i>MUST NOT</i> be included.

#### § 7.1.2.4.4 DV ← RD AUTHN RESPONSE - ASSERTION

Element/@Attribute	0..n	Description
		Issuer = RD Recipient = <a href="#">DV</a> or <a href="#">LC</a>
<b>@ID</b>	1	Unique message identifier. <i>MUST</i> identify the message uniquely within the scope of the sender and receiver for a period of at least 12 months.
<b>@Version</b>	1	Version of the SAML protocol. The value <i>MUST</i> be 2.0.
<b>@IssueInstant</b>	1	Time of issuance of the <a href="#">AuthN Response - Assertion</a> .
<b>Issuer</b>	1	<i>MUST</i> contain the <a href="#">EntityID</a> of <a href="#">RD</a> .
<b>Signature</b>	1	<i>MUST</i> contain the Digital signature of the sender for the enveloped message. <i>MUST</i> contain a KeyInfo element with a KeyName element. See <a href="#">Signature</a> .
<b>Subject</b>	1	<i>MUST</i> be included.
<b>-NameID</b>	1	NameID <i>MUST</i> contain a TransientID.
<b>-SubjectConfirmation</b>	1	Contains the SubjectConfirmation conform the WebSSO profile. See also: <a href="#">SubjectConfirmation</a> .
<b>Conditions</b>	1	<a href="#">NotBefore</a> and <a href="#">NotOnOrAfter</a> limit the window during which the assertion can be delivered. See also: <a href="#">Conditions</a> .
<b>-@NotBefore</b>	1	<i>MUST</i> be included.
<b>-@NotOnOrAfter</b>	1	<i>MUST</i> be included.
<b>-AudienceRestriction</b>	1	<i>MUST</i> be included.
<b>--Audience</b>	1..n	<i>MUST</i> contain an <a href="#">EntityID</a> for all relevant parties that are intended to receive and process this assertion, as per SAML WebSSO profile. See below under <a href="#">Audience restriction</a>
<b>AuthnStatement</b>	1	<i>MUST</i> be included.
<b>-@AuthnInstant</b>	1	<i>MUST</i> contain the time of creation of the enclosing <a href="#">AuthN Response - Assertion</a> .
<b>-SessionIndex</b>	0..1	Conditional, <i>MUST</i> contain the same TransientID as <a href="#">NameID</a> . Is used to uniquely identify a session in case of a federated logout-request <a href="#">see Federated Logout-request message</a> .  <i>NOTE: For future proof better add SessionIndex element which will probably replace @NameID for LogOut request.</i>
<b>-AuthnContext</b>	1	<i>MUST</i> be included.
<b>--AuthnContextClassRef</b>	1	<i>MUST</i> contain the <a href="#">LoA</a> at which authentication took place. Contains the obtained effective Level of assurance, see below under <a href="#">LoA</a> .  <i>NOTE: different rules for RD → AD/BVD</i>
<b>--AuthenticatingAuthority</b>	0..n	<i>MUST</i> contain the <a href="#">EntityID</a> (s) of all authorities that were involved in the authentication and representation except for the assertion issuer.
<b>AttributeStatement</b>	0..1	Conditional. <i>MUST</i> be included if <a href="#">StatusCode</a> is urn:oasis:names:tc:SAML:2.0:status:Success. <i>MUST NOT</i> be included

Element/@Attribute	0..n	Description
		otherwise. <i>MUST</i> contain a single <a href="#">attributestatement</a> in accordance with the section <a href="#">Attributestatement</a> below and the <a href="#">rules for processing an AuthN Response</a> .
<b>Advice</b>	0..1	Conditional. <i>MUST NOT</i> be used for <a href="#">RD</a> – <a href="#">AD/BVD</a> . For <a href="#">DV/LC</a> – <a href="#">RD</a> <i>MUST</i> contain the original assertions received from the <a href="#">AD</a> and <a href="#">BVD</a> (if applicable) that were involved in processing the <a href="#">AuthN Request message</a> .  <i>NOTE: different rules for RD – AD/BVD</i>
<b>-Assertion</b>	1..n	Contains the original Assertion elements this assertion is composed of: <i>MUST</i> contain the original <a href="#">AD</a> Assertion. <i>MAY</i> contain the original Assertion of the <a href="#">BVD</a> in case of representation.

#### § 7.1.2.4.4.1 AUDIENCE RESTRICTION - DV

The [AudienceRestriction](#) element in the [AuthN Response - Assertion](#) must be checked in terms of content. An [AuthN Response - Assertion](#) may only be processed if the [AudienceRestriction](#) contains the [EntityID](#) of the recipient.

The values for DVs included in [Audience](#) are reflected in the [Recipient](#) attribute of the [EncryptedID](#) element in the [Attributestatement](#). This does not apply to the [LC](#) or [RD](#) that is only included in the [AudienceRestriction](#). The [LC](#) or [RD](#) is not, after all, an entity which may receive identities.

#### § 7.1.2.4.4.2 LEVEL OF ASSURANCE VALIDATION

The [AuthnContextClassRef](#) in the [AuthN Response - Assertion](#) always states the authentication level at which the citizen has authenticated himself. [DV](#)'s *MUST* be prepared for the [AuthnContextClassRef](#) to contain a higher [LoA](#) than the requested [LoA](#). [DV](#)'s *MUST* accept authentications with a level equal to or higher than the minimum level registered for the [Service](#) in the [Service Catalog](#). [DV](#) must configure minimum [LoA](#) for the [Service](#) when providing information in the onboarding process. The [AD](#) is responsible for providing the correct [LoA](#) for a given authentication request (equal to or higher than the [LoA](#) registered for the [Service](#) in the [Service Catalog](#))

#### § 7.1.2.4.4.3 SUBJECTCONFIRMATION - DV

The [SubjectConfirmation](#) exists in a [Subject](#) and is used to hold a bearer confirmation in a [AuthN Response - Assertion](#) to an [AuthN Request message](#), to conform to the WebSSO profile. In case a relying party is requesting authentication of an [EU](#) according to the SAML Web SSO profile, a bearer [SubjectConfirmation](#) (see [[SAML2.PROFILES](#)], §3.3 and §4.1.4) must be provided. The [NotOnOrAfter](#) in the [SubjectConfirmationData](#) element limits the time during which the [AuthN Response - Assertion](#) result *MAY* be used to establish an authenticated session for the [EU](#) using the [AuthN Response - Assertion](#). The [NotOnOrAfter](#) is initially set to +2 minutes relative to the time of issuance of the enclosing [AuthN Response - Assertion](#). These values can be changed however in time. The `dv-authn-response-assertion/NotBefore` attribute *MUST NOT* be used.

Element/@Attribute	0..n	Description
<b>SubjectConfirmation</b>	1	Allows for association of client with assertion to conform to the SAML Web SSO profile.
<b>-@Method</b>	1	<i>MUST</i> contain the value <code>urn:oasis:names:tc:SAML:2.0:cm:bearer</code> .
<b>-SubjectConfirmationData</b>	1	<i>MUST</i> be included.
<b>--@NotOnOrAfter</b>	1	A time instance at which the subject can no longer be confirmed.
<b>--@Recipient</b>	1	The assertion consumer Service URL of the immediate requester to which an attesting entity can present the assertion.

Element/@Attribute	0..n	Description
--@InResponseTo	1	The <u>ID</u> of the <u>AuthN Request message</u> this <u>AuthN Response - Assertion</u> is in response to.

#### § 7.1.2.4.4.4 CONDITIONS

The NotBefore and NotOnOrAfter in the Conditions element limit the time during which the AuthN Response - Assertion is considered valid within a prior established authenticated EU session based on this AuthN Response - Assertion. The value of these attributes should be aligned with the maximum session duration (which may be dependent on the LoA) and typically is much longer than the validity of the SubjectConfirmation .

#### § 7.1.2.4.5 ATTRIBUTE STATEMENT - DV

The AuthN Response - Assertion when present *MUST* contain an attributestatement. An attributestatement contains one or more Attribute elements and *MUST* contain exactly one Attribute with @Name="urn:n1-eid-gdi:1.0:ActingSubjectID". It *MAY* contain exactly one Attribute element with @Name="urn:n1-eid-gdi:1.0:LegalSubjectID" indicating representation. Both ActingSubjectID and LegalSubjectID Attributes *MUST* contain one or more AttributeValues for one or more Recipients (e.g. DV). And these Recipients must be included in the AudienceRestriction element.

Element/@Attribute	0..n	Description
<b>AttributeStatement</b>	1	<i>MUST</i> be included.
<b>-Attribute</b>	1..n	See the tables below for details.
--@Name	1	<i>MUST</i> contain the type of the attribute.
--Attribute Value	1..n	The Attribute <i>MUST</i> contain one or more AttributeValues.

#### § 7.1.2.4.6 ENCRYPTEDID

Both ActingSubjectID as LegalSubjectID (Attribute with @Name="urn:n1-eid-gdi:1.0:ActingSubjectID" respectively @Name="urn:n1-eid-gdi:1.0:LegalSubjectID") are unencrypted Attributes and *MUST* contain one or more AttributeValues. Each of these AttributeValues *MUST* contain exactly one EncryptedID element.

Element/@Attribute	0..n	Description
<b>EncryptedID</b>	1	<i>MUST</i> contain one encrypted NameID element. See below for details.
<b>-EncryptedData</b>	1..n	<i>MUST</i> contain the encrypted data containing the XML encrypted NameID which contains the identity.
<b>-EncryptedKey</b>	1..n	<i>MUST</i> contain the wrapped decryption keys, as defined by [XML.ENC]. This element <i>MUST</i> include the intended <u>Recipient</u>
--@Recipient	1	The recipient for which this <u>EncryptedID</u> is intended. This attribute <i>MUST</i> contain an <u>EntityID</u> .

See also: Example EncryptedID

#### § 7.1.2.4.6.1 NAMEID - AFTER DECRYPTING ENCRYPTEDID

An EncryptedID *MUST* contain a SAML NameID after decryption, with the following properties:

- The @Format attribute *MUST* be set to urn:oasis:names:tc:SAML:2.0:nameid-format:persistent.

- The @NameQualifier attribute *MUST* be populated with the full name of the type of identifying attribute (see [Attribute Identifier Types](#) for the @NameQualifier types).
- The attributes @SPNameQualifier and @SPProvidedID *MUST NOT* be used.
- In case more than one certificate is listed for encryption for the recipient in the metadata, the content-encryption-key *MUST* be encrypted for each certificate. This will result in multiple [EncryptedKey](#) each with the same [Recipient](#).

See also: [Example NameID \(after decryption\)](#)

#### § 7.1.2.4.6.2 MULTIPLE RECIPIENTS

SAML and XML-encryption allow for multiple recipients of the same encrypted element. The construct for this is specified in more detail in errata E43 of [[SAML2.ERRATA.05](#)]. In case of multiple recipients:

- each [EncryptedKey](#) *MUST* have a CarriedKeyName equal to the KeyName used in the KeyInfo of the [EncryptedData](#).
- each [EncryptedKey](#) *SHOULD* have a ReferenceList referring back to the data encrypted with the symmetric key contained.

Upon decryption, elements without an [EncryptedKey](#) intended for the decrypting recipient *MAY* be ignored and [EncryptedKey](#) for other recipients of encrypted elements *SHOULD* be ignored.

#### NOTE:

When copying encrypted XML elements ([EncryptedID](#)) to create a summary declaration [RD](#) substitutes XML identifiers for the EncryptedID's with a unique identifier. This *MAY* be accomplished by pre- or suffixing the original identifier in the copy.

Rationale: @ID values must uniquely identify the elements which bear them. Identifiers that appear in the summary assertion and also in the advice assertion(s) will break XML validation.

If the type of identity is urn:n1-eid-gdi:1.0:id:legacy-BSN, only one [EncryptedData](#) element *MUST* be used in combination with one or more [EncryptedKey](#) elements (one for each recipient).

Because a polymorphic identity or pseudonym of a single person will be distinct for different recipients by design, a single [EncryptedData](#) element cannot be used when encryption for multiple recipients is required. Therefore, for each recipient, one [EncryptedData](#) element paired with one [EncryptedKey](#) element *MUST* be used.

Although a [LC](#) or [RD](#) may be an [Audience](#) as it will process the SAML Assertion, it is not a [Subject Confirmation - @Recipient](#) and will not be able to decrypt [EncryptedID](#)'s.

#### § Generic attributes

In all cases the following attributes will be provided as an unencrypted [Attribute](#).

Attribute	1..n	Attribute Name	Description
ServiceUUID	1	Name="urn:n1-eid-gdi:1.0:ServiceUUID"	
- AttributeValue	1..n		The ServiceUUID of the <a href="#">Service Catalog</a> for which this Assertions is intended as indicated in the <a href="#">AuthN Request message</a> . In case of legal representation the <a href="#">ServiceUUID</a> will be a copy of <a href="#">Attribute</a> in <a href="#">AuthN Request message</a>

§ Attribute types in case of legal representation

In case of legal representation, via [BVD](#) the following attribute will be provided as an unencrypted [Attribute](#).

Type	1..n	Attribute Name	Description
RepresentationType	0-1	Name="urn:nl-eid-gdi:1.1:RepresentationType"	Optional for DigiD Machtigen, required for any type of legal representation by the <a href="#">BVD</a>
-AttributeValue	1..n		The <a href="#">type of representation</a> , to be used by Service Provider <a href="#">DV</a> for access decision multiple values of <a href="#">Legal Representation</a> allowed.

§ Attribute types in case of authentication

In case of authentication the following attributes will be provided as [EncryptedID](#).

Attribute	1..n	Attribute Name	Description
ActingSubjectID	1	Name="urn:nl-eid-gdi:1.0:ActingSubjectID".	
-AttributeValue	1..n		All contain identities of the same <a href="#">EU</a> .

§ Attribute types issuer in case of representation

In case of representation the following attributes will be provided as [EncryptedID](#)

Type	1..n	Attribute Name	Description
<b>ActingSubjectID</b>	1	Name="urn:nl-eid-gdi:1.0:ActingSubjectID"	Identity of the EndUser ( <a href="#">EU</a> )
-AttributeValue	1..n		The (encrypted) ActingSubjectID as received from the AD at which the <a href="#">EU</a> was authenticated. All contain identities of the same <a href="#">EU</a> .
<b>LegalSubjectID</b>	1	Name="urn:nl-eid-gdi:1.0:LegalSubjectID"	Identity of the <a href="#">Represented Party</a>
-AttributeValue	1..n		The (encrypted) LegalSubjectID as received from BVD. All contain identities of the same <a href="#">Represented Party</a> .

§ Attribute type conversion eTD

In case of authentication with eTD the following Attributes will be provided as [EncryptedID](#)

Type	1..n	eTD Name	ST-SAML Name	Description
Attribute	0..1	urn:etoegang:core:ActingSubjectID	urn:nl-eid-gdi:1.0:ActingSubjectID	Identity of the EndUser ( <a href="#">EU</a> )
-- AttributeValue	1..n			All contain identities of the same <a href="#">EU</a> .

Type	1..n	eTD Name	ST-SAML Name	Description
Attribute	0..1	urn:etoegang:core:LegalSubjectID	urn:nl-eid-gdi:1.0:LegalSubjectID	Identity of the <a href="#">Represented Party</a>
-- AttributeValue	1..n			All contain identities of the same <a href="#">Represented Party</a> .

Other scenario's (e.g. support for IntermediarySubjectID) are not yet supported and may be added in future iterations of this specification. Attributes from eTD as included in the HM summary assertion will be copied unaltered into the AttributeStatement of the [RD](#). They may contain either [EncryptedID](#) or EncryptedAttribute elements. See <https://afsprakenstelsel.etoegang.nl/Startpagina/as/attribuutcatalogus>

#### § EXAMPLE ATTRIBUTE STATEMENT FOR LEGAL REPRESENTATION

```
<saml2:AttributeStatement>
  <saml2:Attribute Name="urn:nl-eid-gdi:1.1:RepresentationType">
    <saml2:AttributeValue>urn:nl-eid-gdi:1.1:RT:Zorg_Volledig_Gezag_Kind</saml2:Attribute
  </saml2:Attribute>
  ...
  <saml2:Attribute Name="urn:nl-eid-gdi:1.0:ActingSubjectID">
    <saml2:AttributeValue>
      // EncryptedID with BSN of ActingSubject (ouder/voogd)
    </saml2:AttributeValue>
  </saml2:Attribute>
  <saml2:Attribute Name="urn:nl-eid-gdi:1.0:LegalSubjectID">
    <saml2:AttributeValue>
      // EncryptedID with BSN LegalSubject (kind)
    </saml2:AttributeValue>
  </saml2:Attribute>
</saml2:AttributeStatement>
```

#### § EXAMPLE ENCRYPTEDID

```
<saml2:EncryptedID xmlns:saml2="urn:oasis:names:tc:SAML:2.0:assertion"
  xmlns:xenc="http://www.w3.org/2001/04/xmlenc#"
  xmlns:ds="http://www.w3.org/2000/09/xmldsig#">
  <xenc:EncryptedData
    xmlns:xenc="http://www.w3.org/2001/04/xmlenc#"
    Id="_cd52e15a16e2a0aa751725ce76a6b866"
    Type="http://www.w3.org/2001/04/xmlenc#Element">
    <xenc:EncryptionMethod
      Algorithm="http://www.w3.org/2001/04/xmlenc#aes256-cbc"
      xmlns:xenc="http://www.w3.org/2001/04/xmlenc#" />
    <ds:KeyInfo xmlns:ds="http://www.w3.org/2000/09/xmldsig#">
      <ds:RetrievalMethod
        Type="http://www.w3.org/2001/04/xmlenc#EncryptedKey"
        URI="#_15531f77a9f1e0b5e0cce442aa31bbd4" />
      </ds:KeyInfo>
    <xenc:CipherData xmlns:xenc="http://www.w3.org/2001/04/xmlenc#">
      <xenc:CipherValue>AZkW3hbBaQkxs...</xenc:CipherValue>
    </xenc:CipherData>
  </xenc:EncryptedData>
  <xenc:EncryptedKey xmlns:xenc="http://www.w3.org/2001/04/xmlenc#"
    Id="_449673558dd0810e91009297f56fd051"
    Recipient="urn:nl-eid-gdi:1.0:DV:000000099999999999004:entities:0000">
    <xenc:EncryptionMethod
      Algorithm="http://www.w3.org/2001/04/xmlenc#rsa-oaep-mgf1p"
      xmlns:xenc="http://www.w3.org/2001/04/xmlenc#">
```

```

    <ds:DigestMethod Algorithm="http://www.w3.org/2000/09/xmldsig#sha1" />
  </xenc:EncryptionMethod>
  <ds:KeyInfo xmlns:ds="http://www.w3.org/2000/09/xmldsig#">
    <ds:KeyName>...</ds:KeyName>
  </ds:KeyInfo>
  <xenc:CipherData xmlns:xenc="http://www.w3.org/2001/04/xmlenc#">
    <xenc:CipherValue>yRy923JJlgAi2MTgx1qohLiDBgi...</xenc:CipherValue>
  </xenc:CipherData>
  <xenc:ReferenceList>
    <xenc:DataReference URI="#_cd52e15a16e2a0aa751725ce76a6b866" />
  </xenc:ReferenceList>
  </xenc:EncryptedKey>
</saml2:EncryptedID>

```

#### § EXAMPLE NAMEID (AFTER DECRYPTION)

```

<saml2:NameID
  xmlns:saml2="urn:oasis:names:tc:SAML:2.0:assertion"
  Format="urn:oasis:names:tc:SAML:2.0:nameid-format:persistent"
  NameQualifier="urn:n1-eid-gdi:1.0:id:legacy-BSN">999999047</saml2:NameID>

```

#### § DV ← RD AuthN Response - Message processing rules for DV

Regardless of the SAML binding used, the service provider *MUST* do the following:

1. Verify any signatures present on the [AuthN Response - Assertion](#) or the [AuthN Response - Assertion](#).
2. Verify that the **dv-subjectconfirmation/@Recipient** attribute in any bearer [Subject Confirmationdata](#) matches the assertion consumer service URL to which the [AuthN Response - Assertion](#) or [Artifact](#) was delivered.
3. Verify that the [@NotOnOrAfter](#) attribute in any bearer [Subject Confirmationdata](#) has not passed, subject to allowable clock skew between the providers.
4. Verify that the [@InResponseTo](#) attribute in the bearer [Subject Confirmationdata](#) equals the [@ID](#) of its original [AuthN Request message](#) message.
5. Verify that its [EntityID](#) is included as [Audience](#) in the [AuthN Response - Assertion](#).
6. Verify that any assertions relied upon are valid in other respects.
7. Any assertion which is not valid, or whose subject confirmation requirements cannot be met *SHOULD* be discarded and *SHOULD NOT* be used to establish a security context for the principal.

## §7.2 RD - SAML Message specification

### § 7.2.1 RD → AD - SAML authentication proces

SAML authentication between [RD](#) and [AD](#) or [BVD](#) are described in this chapter. The [RD → AD/BVD](#) SAML messages are almost identical to the SAML messages of [DV/LC → RD - SAML authentication](#). Therefore only a reference to the appropriate [DV/LC → RD - SAML messages](#) will be given and the differences described.

#### § 7.2.1.1 RD → AD - Authentication - diagram

The diagram below depicts the flow between a [RD](#) and an [AD/BVD](#). The encompassing flow, between [DV/LC](#) and [RD](#), is out of scope (see [\[\[eID SAML4.4\]\]](#) for details).

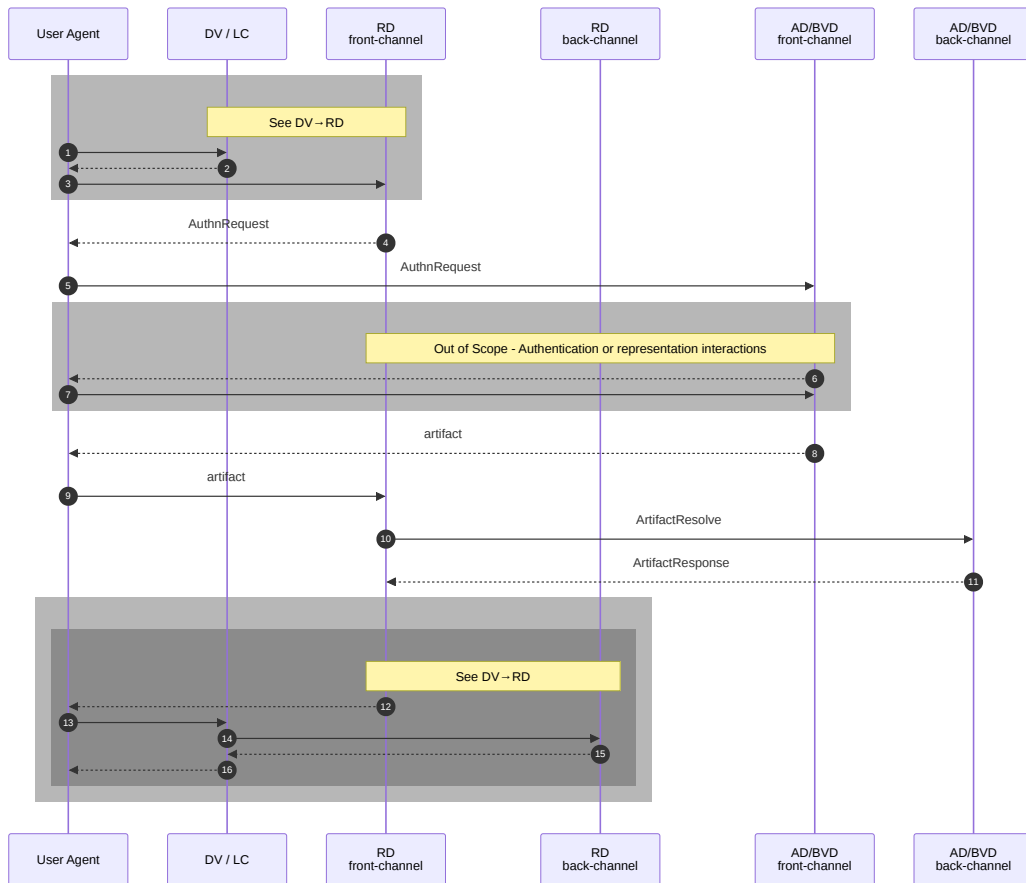

Figure 11 SAML authentication flow RD - AD/BVD

§ 7.2.1.2 RD → AD - Authentication - steps

**Step 1, 2 and 3 (out of scope for this specification)**

For messages between AD and RD see DV-RD authentication diagram

**Step 4 and 5**

The RD will send the EU to an AD for authentication or to a BVD for proof of representation (or both).

**Step 6 and 7 (out of scope for this specification)**

In these steps the EU interacts with an AD or aBVD .

**Step 8 and 9**

The AD/BVD sends the EU back to the RD via a browser redirect. An opaque Artifact generated by AD/BVD is send here in the Artifact Response message. The Artifact refers to the actual SAML response message that is waiting at AD/BVD.

Even if the interactions in step 6 and 7 were unsuccessful or cancelled, an Artifact is send to the RD. This Artifact provides an error message with the Artifact Resolve message and cannot be exchanged for a valid Assertion.

**Step 10**

With the Artifact the result of the (successful or unsuccessful) authentication or representation can be retrieved from the Back channel.

An Artifact Response message is valid for a maximum of 15 minutes and can only be retrieved once by the RD. Situations are possible (process breakdown, early logout) where an Artifact is valid less than 15 minutes.

**Step 11**

[AD/BVD](#) replies with an [Artifact Response message](#) that belongs to the [Artifact](#). In this message, [AD/BVD](#) provides an [Assertion](#) that includes the authentication result or the proof of representation. And, if the authentication / representation selection was successful, the requested (encrypted) identifier(s) and attribute(s) of the [EU](#) or the [Represented Party](#). The identities and attributes are encrypted so that only the intended [DV\(s\)](#) can obtain the plain text value.

If the authentication or attempt to select representation was unsuccessful, it is indicated in the Status Code of the Response message and if possible, a reason is given so that the [DV](#) can inform the [EU](#).

#### § 7.2.1.3 RD → AD/BVD ArtifactResolve

#### Step 12, 13, 14 and 15 (out of scope for this specification)

For messages between [AD](#) and [RD](#) see [DV-RD authentication diagram](#)

#### § 7.2.2 RD → AD - SAML messages

1. The messages contain at least the elements that are specified as mandatory by the standard.
2. In addition, the messages also contain optional elements. It is indicated whether these elements are mandatory, conditional or optional. With optional elements, it is up to the participants to determine whether they are used.
3. Optional SAML elements that are not in this specification *SHOULD NOT* be included. When present they will be ignored when possible.

#### § 7.2.2.1 RD → AD AuthnRequest

When a principal (or an agent acting on the principal's behalf) wishes to obtain assertions containing authentication statements to establish a security context at one or more relying parties, it can use the authentication request protocol to send an [AuthN Request message](#) message element to a SAML authority and request that it returns a [AuthN-Response message](#) containing one or more such assertions.

#### § 7.2.2.1.1 RD → AD AUTHNREQUEST DIAGRAM

The possible sender and recipient of the AuthnRequest message are the following:

Sender	Recipient
<a href="#">RD</a>	<a href="#">AD</a>
<a href="#">RD</a>	<a href="#">BVD</a>

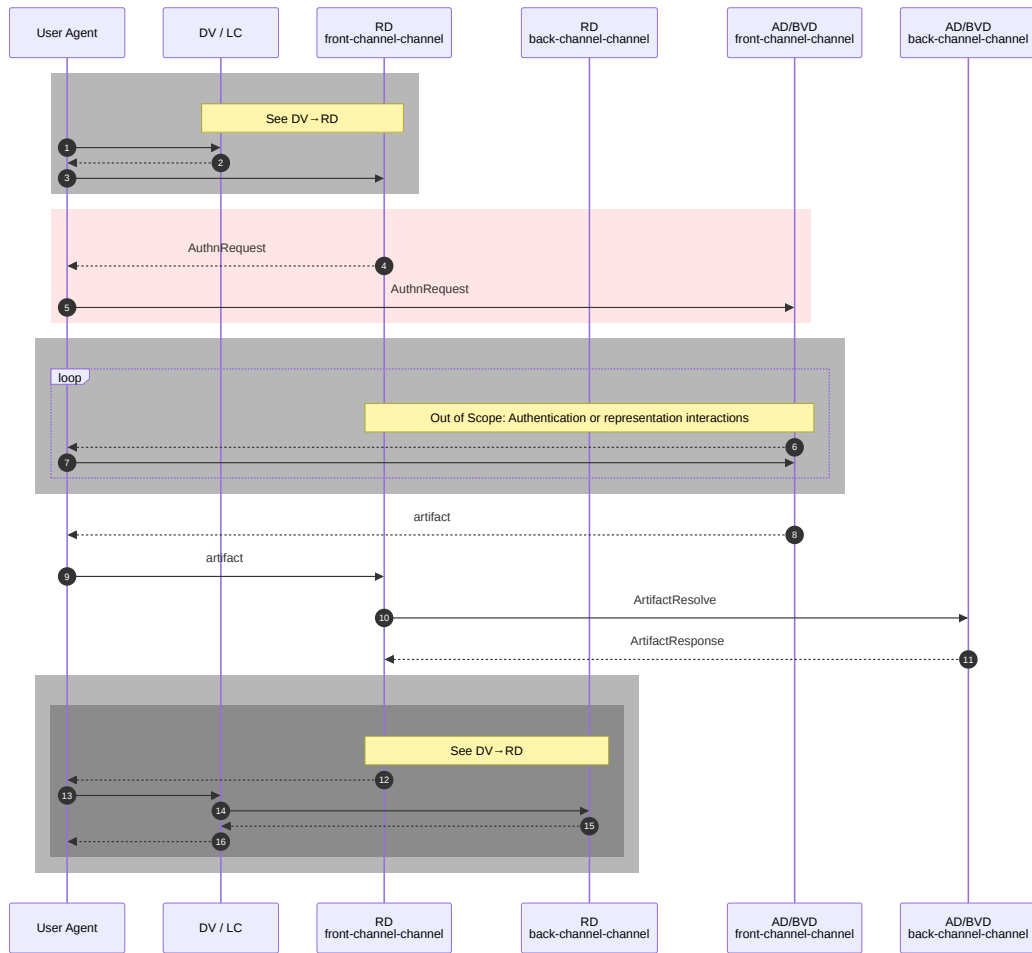

Figure 12 SAML authentication flow - RD - AD/BVD - AuthN-Request

§ 7.2.2.1.2 RD → AD AUTHNREQUEST MESSAGE

See also [Example AuthnRequest with representation from RD to AD](#)

For message specification see [DV/LC → RD - AuthN-Request Message](#)

§ 7.2.2.1.3 AUTHN-REQUEST DIFFERENCES BETWEEN DV/LC → RD, RD → AD AND RD → BVD

Element/@Attribute	DV / LC → RD	RD → AD	RD → BVD
<a href="#">AttributeConsumingServiceIndex</a>	If present, <a href="#">Extensions</a> <i>MUST NOT</i> be present. Forbidden for <a href="#">LC</a>	<i>MUST</i> not be present (ignored)	<i>MUST</i> not be present (ignored)
<a href="#">Extensions</a>	If present, <a href="#">AttributeConsumingServiceIndex</a> <i>MUST NOT</i> be present. Mandatory for <a href="#">LC</a>	Mandatory	Mandatory
- <a href="#">Attribute</a> with @Name="urn:nl-eid-gdi:1.0:IntendedAudience"	Mandatory if <a href="#">Extensions</a> is present	Mandatory	Mandatory
- <a href="#">Attribute</a> with @Name="urn:nl-eid-gdi:1.0:IdpAssertion"	<i>MUST NOT</i> be present (ignored)	<i>MUST NOT</i> be present	<i>MUST</i> be present and contain an

Element/@Attribute	DV / LC → RD	RD → AD	RD → BVD
		(ignored)	<a href="#">AttributeValue</a> holding an <a href="#">Assertion</a> received from a compliant <a href="#">AD</a> .
<a href="#">Scoping-RequesterID</a>	Optional	Optional	<i>MUST NOT</i> be present (ignored)

#### § 7.2.2.1.4 RD → AD AUTHNREQUEST PROCESSING RULES

In addition to the processing rules required by the SAML specification the following rule applies. If any of these validations fails, the authentication *MUST* fail:

##### 1. [AD](#) *MUST*:

- validate that the [DV](#) is registered for the requested [ServiceUUID](#) referenced by the index in the [DV metadata](#) or the [Extensions element of the DV AuthN-request](#) and that the registration is valid;
- (in case when an [LC](#) is involved) validate that the [DV](#) is registered to use the requested [ServiceUUID](#) with the [LC](#) that sends the [AuthN Request Message](#) on behalf of the [DV](#) and that the registration is valid;
- If any of these validations fails, the authentication *MUST* fail.

##### 1. [AD BVD](#) *MUST* validate that the [DV](#) is registered for the requested [ServiceUUID](#) referenced by the index in the [DV metadata](#) or the [Extensions element of the DV AuthN-request](#) and that the registration is valid;

#### § 7.2.2.2 RD ← AD Response - Artifact Binding

The SAML response of a [AD](#) or [BVD](#) to a SAML request of a [RD](#) uses an [Artifact-Binding](#) for extra security see [[SAML2.BINDINGS](#)] section 3.6.6. Therefore SAML Response does not return the actual SAML message with an Authentication Assertion but an [Artifact](#) as a reference to actual the SAML [AuthN Response - Assertion](#) message. The Artifact is used by the [DV](#) (or [LC](#)) to retrieve the SAML [AuthN Response - Assertion](#) at the [RD](#).

#### § 7.2.2.2.1 RD ← AD RESPONSE - ARTIFACT BINDING - DIAGRAM{#RD-RESPONSE-ARTIFACT-BINDING}

The possible sender and recipient of the AuthnRequest message are the following:

Sender	Recipient
<a href="#">AD</a>	<a href="#">RD</a>
<a href="#">BVD</a>	<a href="#">RD</a>

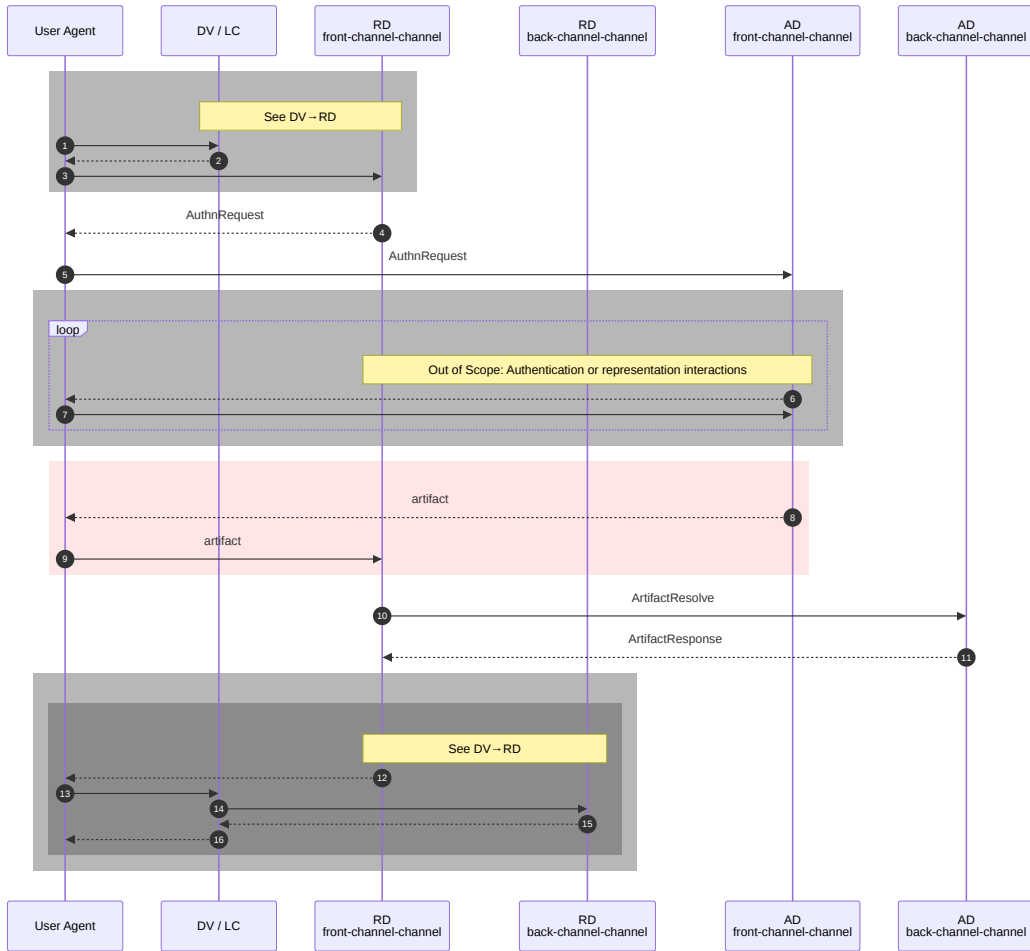

Figure 13 SAML authentication flow - RD - AD/BVD Artifact Binding

§ 7.2.2.2.2 RD ← AD RESPONSE - ARTIFACT BINDING - MESSAGE

The receiver of the previous [AuthN Request message](#) sends a SAML [Artifact](#) message via the front channel by a redirect to the [AssertionConsumerService](#) referenced in the [AuthN Request message](#). An [Artifact](#) is a reference to the SAML [AuthN Response - Assertion](#) message. Even if no authentication has taken place, an Artifact will be send. The Artifact message is send to the recipient via an HTTP Redirect. The [Artifact](#) is used by the receiver to retrieve the SAML [AuthN Response - Assertion](#) at the sender.

§ 7.2.2.3 RD → AD ArtifactResolve

§ 7.2.2.3.1 RD → AD ARTIFACTRESOLVE DIAGRAM

The [Artifact Resolve](#) request is send via a SOAP binding over the [Back channel](#). The back channel is protected with two-sided TLS authentication. The receiver will return an [AuthN Response message](#) in the response message. The sender and recipient of the [Artifact Resolve](#) are the following:

Sender	Recipient
<a href="#">RD</a>	<a href="#">AD</a>
<a href="#">RD</a>	<a href="#">BVD</a>

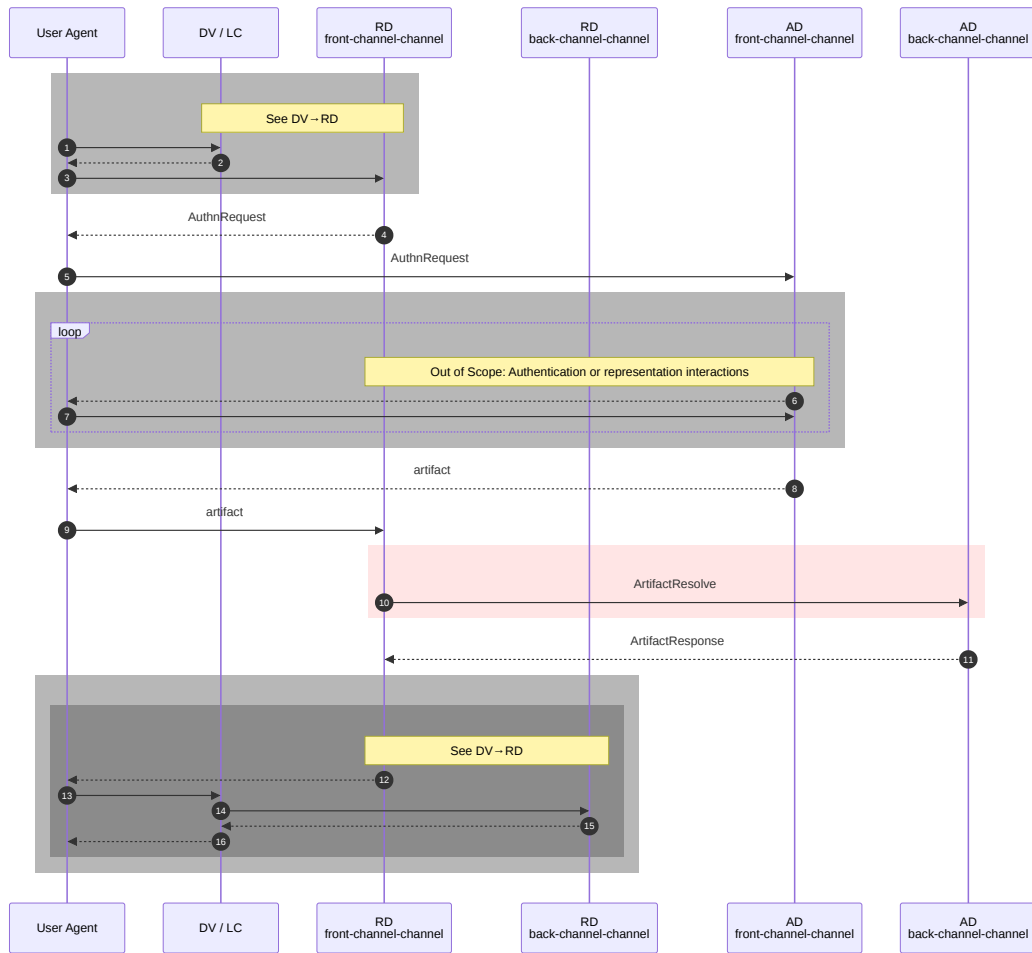

Figure 14 SAML authentication flow - RD - AD/BVD Artifact Resolve

§ 7.2.2.3.2 RD → AD ARTIFACTRESOLVE MESSAGE

For message specification see [DV/LC → RD - ArtifactResolve Message](#)

§ 7.2.2.4 RD → AD ArtifactResponse

The [AuthN Response message](#) contains the response message to the [Artifact Resolve](#) request in a SOAP message. This response message in turn contains the [AuthN Response - Assertion](#) to the Original [AuthN Request message](#). The sender will send the [AuthN Response message](#) in response to an [Artifact Resolve](#) request. If successful it contains the [AuthN Response - Assertion](#) to the [AuthN Request message](#).

§ 7.2.2.4.1 RD ← AD ARTIFACTRESPONSE DIAGRAM

The sender and recipient of the [Artifact Response](#) are the following:

Sender	Recipient
<a href="#">AD</a>	<a href="#">RD</a>
<a href="#">BVD</a>	<a href="#">RD</a>

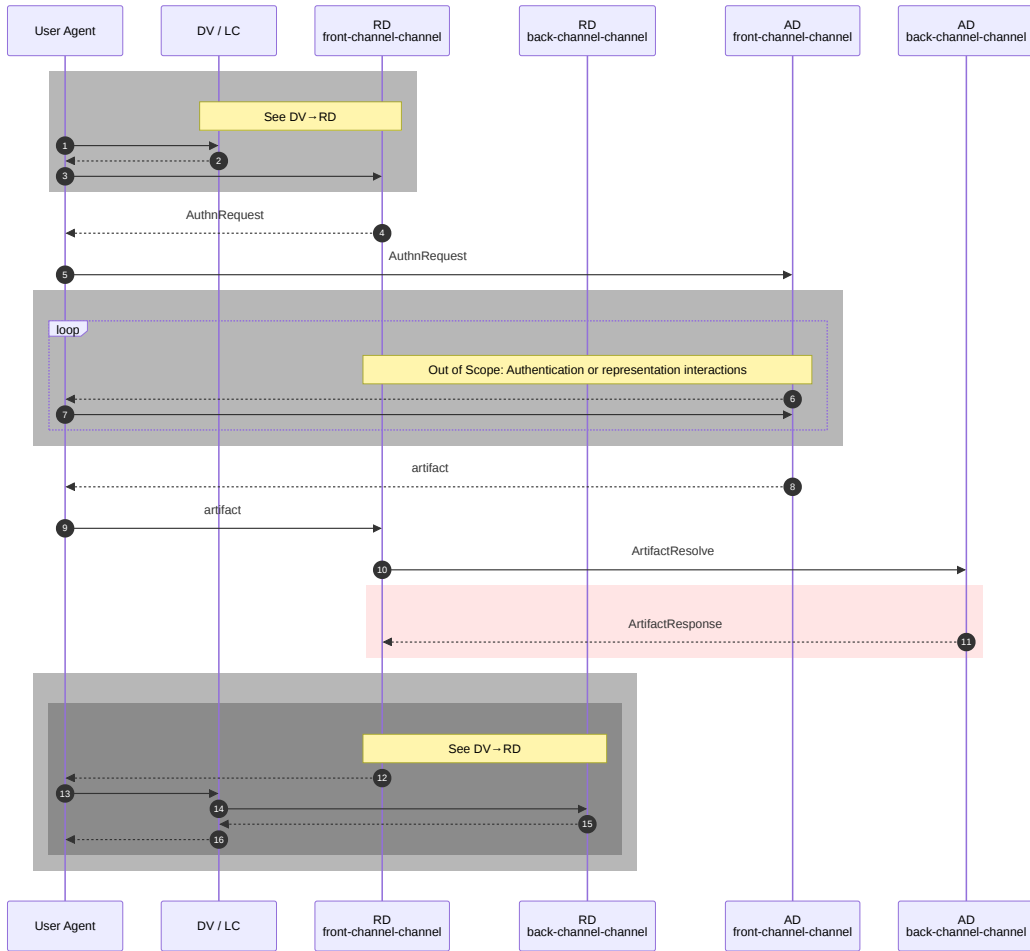

Figure 15 SAML authentication flow - RD - AD/BVD Artifact Response

§ 7.2.2.4.2 RD ← AD ARTIFACT RESPONSE MESSAGE

For message specification see [DV/LC ← RD - ArtifactResponse Message](#)

§ 7.2.2.4.3 RD ← AD AUTHN RESPONSE - MESSAGE

The [SAML Response Message](#) to the [AuthN Request message](#) contains the authentication assertion if authentication was successful.

For message specification see [DV/LC ← RD - AuthN Response - Message](#)

§ 7.2.2.4.4 RD ← AD AUTHN RESPONSE - ASSERTION

For Assertion specification see [DV/LC ← RD - AuthN Response - Assertion](#)

For AttributeStatement specification see [DV/LC ← RD - AuthN Response - AttributeStatement](#)

§ 7.2.2.4.5 ASSERTION AND ATTRIBUTE STATEMENT DIFFERENCES BETWEEN DV/LC ← RD AND RD ← AD/BVD

Element/@Attribute	DV / LC ← RD	RD ← AD	RD ← BVD
<a href="#">Conditions</a> <a href="#">-AudienceRestriction</a> <a href="#">--Audience</a>	<p><i>MUST</i> contain <a href="#">EntityID</a> of <a href="#">DV</a> and (if applicable) <a href="#">LC</a>.</p>	<p><i>MUST</i> contain <a href="#">EntityID</a> of <a href="#">RD</a> and (in case of representation) <a href="#">BVD</a>.</p>	<p><i>MUST</i> contain <a href="#">EntityID</a> of <a href="#">RD</a>.</p>
<a href="#">AuthnStatement</a> <a href="#">-AuthnContext</a> <a href="#">--AuthnContextClassRef</a>	<p><i>MUST</i> be present.</p>	<p><i>MUST</i> be present.</p>	<p><i>MUST</i> be <code>urn:oasis:names:tc:SAML:2.0:ac:classes:unsp</code></p>
<a href="#">--AuthenticatingAuthority</a>	<p><i>MUST</i> contain the <a href="#">EntityID</a> of <a href="#">AD</a> and (in case of representation respectively legal representation) <a href="#">BVD-DDM</a> or <a href="#">BVD-OG</a>.</p>	<p><i>MUST NOT</i> be present.</p>	<p><i>MUST NOT</i> be present.</p>
<a href="#">attributestatement</a> <a href="#">-attribute</a> with <code>Name="urn:nl-eid-gdi:1.0:ActingSubjectID"</code>	<p><i>MUST</i> be present and <i>MUST</i> be decipherable for <a href="#">DV</a>.</p>	<p><i>MUST</i> be present and <i>MUST</i> be decipherable for <a href="#">DV</a> and (in case of representation respectively legal representation) <a href="#">BVD-DDM</a> or <a href="#">BVD-OG</a>.</p>	<p><i>MUST</i> be present and <i>MUST</i> be decipherable for <a href="#">DV</a>.</p>
<a href="#">attributestatement</a> <a href="#">-attribute</a> with <code>[=dv-attributestatement/=Name=]"urn:nl-eid-gdi:1.0:LegalSubjectID"</code>	<p>In case of representation <i>MUST</i> be present and <i>MUST</i> be decipherable for <a href="#">DV</a>.</p>	<p><i>MUST NOT</i> be present.</p>	<p><i>MUST</i> be present and <i>MUST</i> be decipherable for <a href="#">DV</a>.</p>
<a href="#">attributestatement</a> <a href="#">-attribute</a> with <code>Name="urn:nl-eid-gdi:1.1:RepresentationType"</code>	<p>In case of legal representation <i>MUST</i> be present and <i>MUST</i> be used by <a href="#">DV</a> when deciding on access.</p>	<p><i>MUST NOT</i> be present.</p>	<p><i>MUST</i> be present</p>
<a href="#">Advice</a>	<p><i>MUST</i> be present.</p>	<p><i>MUST NOT</i> be present.</p>	<p><i>MUST NOT</i> be present.</p>

## §7.3 Federated Logout Message specification

### § 7.3.1 DV → RD login & logout

#### NOTE

Support for federated login and logout may be subject to change in future versions of this specification. [DV/LCs](#) which decide to make use of federated login and logout, as supported by this version of the specification, must be prepared to make all the necessary changes to their use of federated login and logout as soon as a later version of the specification mandates such changes.

Support for federated login and logout in future versions of this specification will adhere to policies that are expected to emerge from the broader discussion about federated login and logout in the context of the eIDAS regulation.

Most notably, support for IdP [AD](#) initiated logout may become mandatory in a future version of this specification.

#### § 7.3.1.1 DV Federated Login

Federated Login via a [SSO](#) federation is only supported for multiple connections (websites) of a single [DV](#). Furthermore, [DigiD](#) does not support SSO federation between [[DigiD SAML3.x](#)] and [[eID SAML4.4](#)] (or later) connections.

A [DV](#) who wants to grant access to his services through [SSO](#) can do so via the [SSO](#) service from [RD](#). The [DV](#) then participates in an [SSO](#) federation which may include several websites of the [DV](#) who all want to use the [SSO](#) functionality that is offered within the [SSO](#) federation. Details on the [SSO](#) service are provided by [RD](#). In a number of cases, the [EU](#) is still asked to provide his credentials:

1. The Level of Assurance [LoA](#) that the [DV](#) website requests may be higher than the level of reliability that is stored in the existing [SSO](#) session.
2. The existing [SSO](#) session can apply to a different [SSO](#) federation than the [DV](#) website is a member of.
3. The [DV](#) website can include the ForceAuthn element in the [authentication request](#), with the value True. If a value is not provided or the element is omitted, the default is "False"
4. The existing [SSO](#) session has expired.

#### § 7.3.1.2 DV → RD logout Request - Diagram

A [DV](#) or [LC](#) can send this message to [RD](#) when an [EU](#) logs out at an [DV](#). A [RD](#) can send this message to an [AD](#).

Sender	Recipient
<a href="#">DV</a>	<a href="#">RD</a>
<a href="#">LC</a>	<a href="#">RD</a>

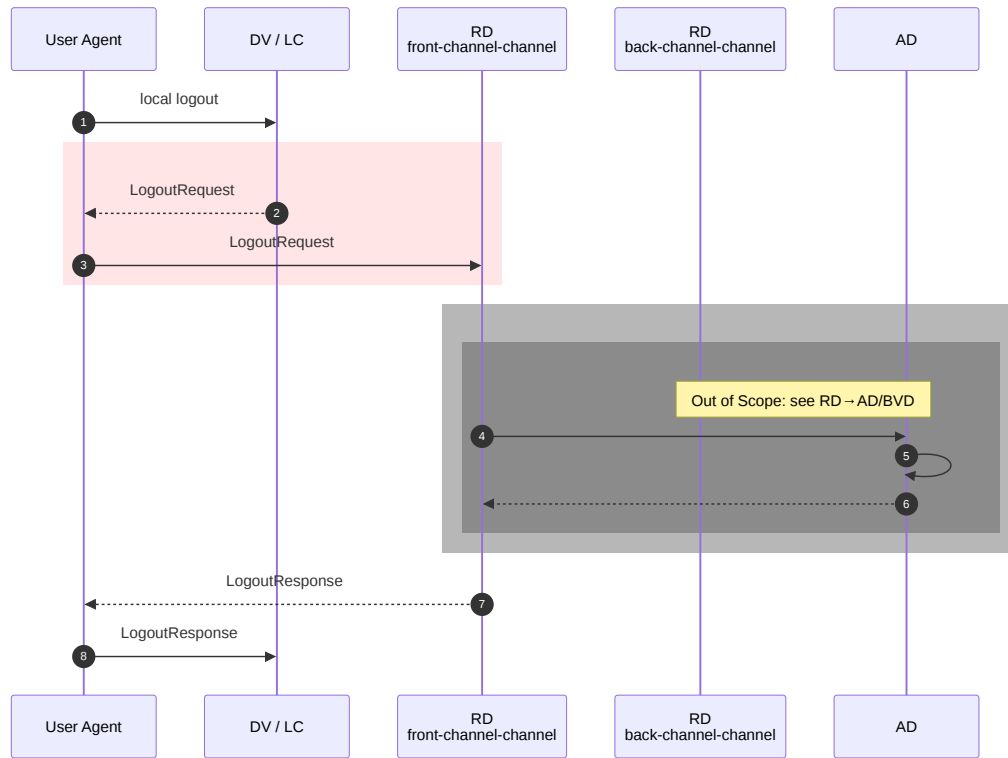

Figure 16 LogoutRequest DV/LC - RD

Only SP (DV) initiated logout is supported by RD. On receiving a logout request (1) a DV which participates in a SSO federation MUST send a Logout request to RD (2b).

This will result in RD to terminate the SSO session if it still was active. As a result, the EU will have to re-authenticate when accessing a DV even if that DV is part of the same SSO federation that was just terminated.

SP initiated logout is limited in the sense that any other active SSO originated sessions with DV's is not actively terminated upon receipt of a SP (DV) initiated logout message. Sessions with other active DV's within the same federation will continue to be active until the local DV session times out or the EU logs out of the DV.

#### § 7.3.1.3 DV → RD logout Request - Message

Element/@Attribute	0..n	Description
@ID	1	Unique message attribute
@Version	1	Version of the SAML protocol. The value MUST be '2.0'.
@IssueInstant	1	Time at which the message was created.
@Destination	1	URL of the recipient on which the message is offered.
Signature	1	MUST contain the Digital signature of the sender for the enveloped message (@Algorithm="http://www.w3.org/2000/09/xmldsig#enveloped-signature"). MUST contain a KeyInfo element with either aKeyName or X509Certificate elements. See Signature.
NameID	1	MUST contain the @NameID NameID element of the original Assertion.
SessionIndex	0..1	Conditional, MUST contain the TransientID SessionIndex element of the original Assertion.
Issuer	1	MUST contain the of the sender.

§ 7.3.1.4 DV ← RD logout Response - Diagram

In response to a [Logout Request message](#) the [RD](#) will send this message to the [DV](#) or [LC](#), or a [AD](#) will send this message to the requesting [RD](#).

Sender	Recipient
<a href="#">RD</a>	<a href="#">DV</a>
<a href="#">RD</a>	<a href="#">LC</a>

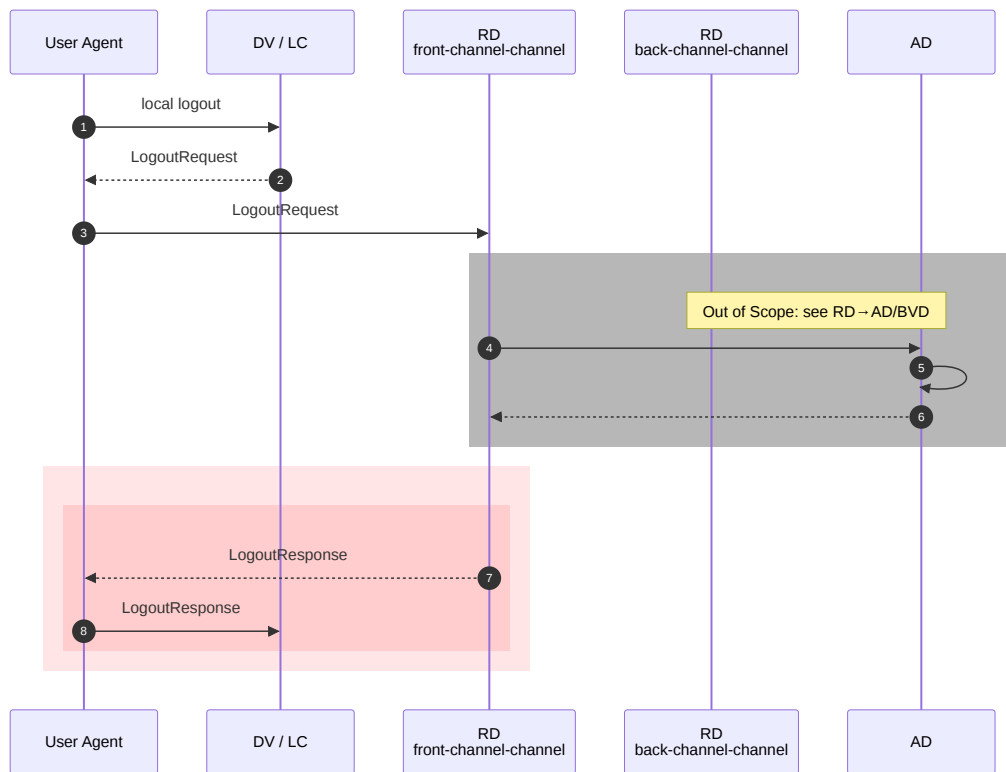

Figure 17 LogoutResponse DV/LC - RD

§ 7.3.1.5 DV ← RD logout Response - Message

Element/@Attribute	0..n	Description
<b>@ID</b>	1	Unique message attribute
<b>@Version</b>	1	Version of the SAML protocol. The value <i>MUST</i> be 2.0.
<b>@IssueInstant</b>	1	Time at which the message was created.
<b>@Destination</b>	1	URL of the recipient on which the message is offered.
<b>@InResponseTo</b>	1	<a href="#">ID</a> of the <a href="#">Logout Request message</a> for which this <a href="#">Logout Response message</a> is the answer.
<b>Signature</b>	1	<i>MUST</i> contain the Digital signature of the sender for the enveloped message (@Algorithm="http://www.w3.org/2000/09/xmldsig#enveloped-signature"). <i>MUST</i> contain a KeyInfo element with a KeyName element. See <a href="#">Signature</a> .
<b>Issuer</b>	1	<i>MUST</i> contain the <a href="#">EntityID</a> of the sender.
<b>Status</b>	1	<i>MUST</i> contain a <a href="#">StatusCode</a> element with the status of the logout.
<b>-StatusCode</b>	1	<i>MUST</i> be present in a <a href="#">Status</a> element.

### § 7.3.2 RD → AD login & logout

This section is extending the [DV/LC → RD SAML Federated login and logout](#) between [RD](#) and [AD](#).

A [RD](#) that supports [SSO](#) to [DV](#) s or [LC](#)s must propagate logout requests to the correct [AD](#) or [AD](#)s. The diagram below depicts the flow between a [RD](#) and an [AD](#). The encompassing flow, between [DV/LC](#) and [RD](#), is out of scope (see [\[\[eID SAML4.4\]\]](#) for details).

#### § 7.3.2.1 RD → AD logout Request - Diagram

A [DV](#) or [LC](#) can send this message to [RD](#) when a user logs out at an [DV](#). A [RD](#) can send this message to an [AD](#).

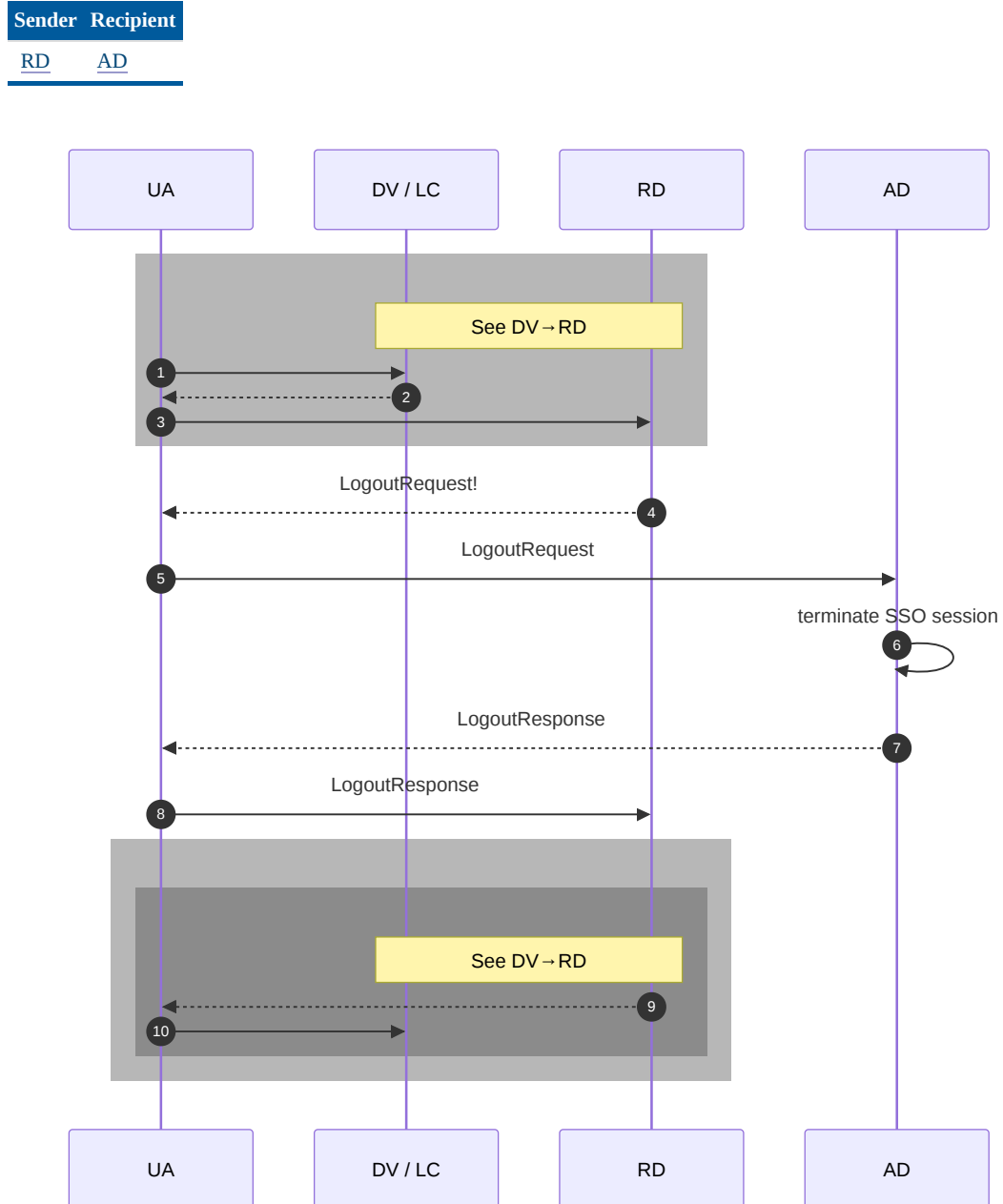

Figure 18 Logout Response RD -AD

§ 7.3.2.2 RD → AD Logout Request - Message

A DV or LC can send this message to RD when a user logs out at an DV. A RD can send this message to an AD. The message is identical to DV/LC → RD SAML Federated Logout Request - Message

§ 7.3.2.3 RD ← AD Logout Response - Diagram

In response to a Logout Request message from RD, an AD will send this message to the requesting RD.

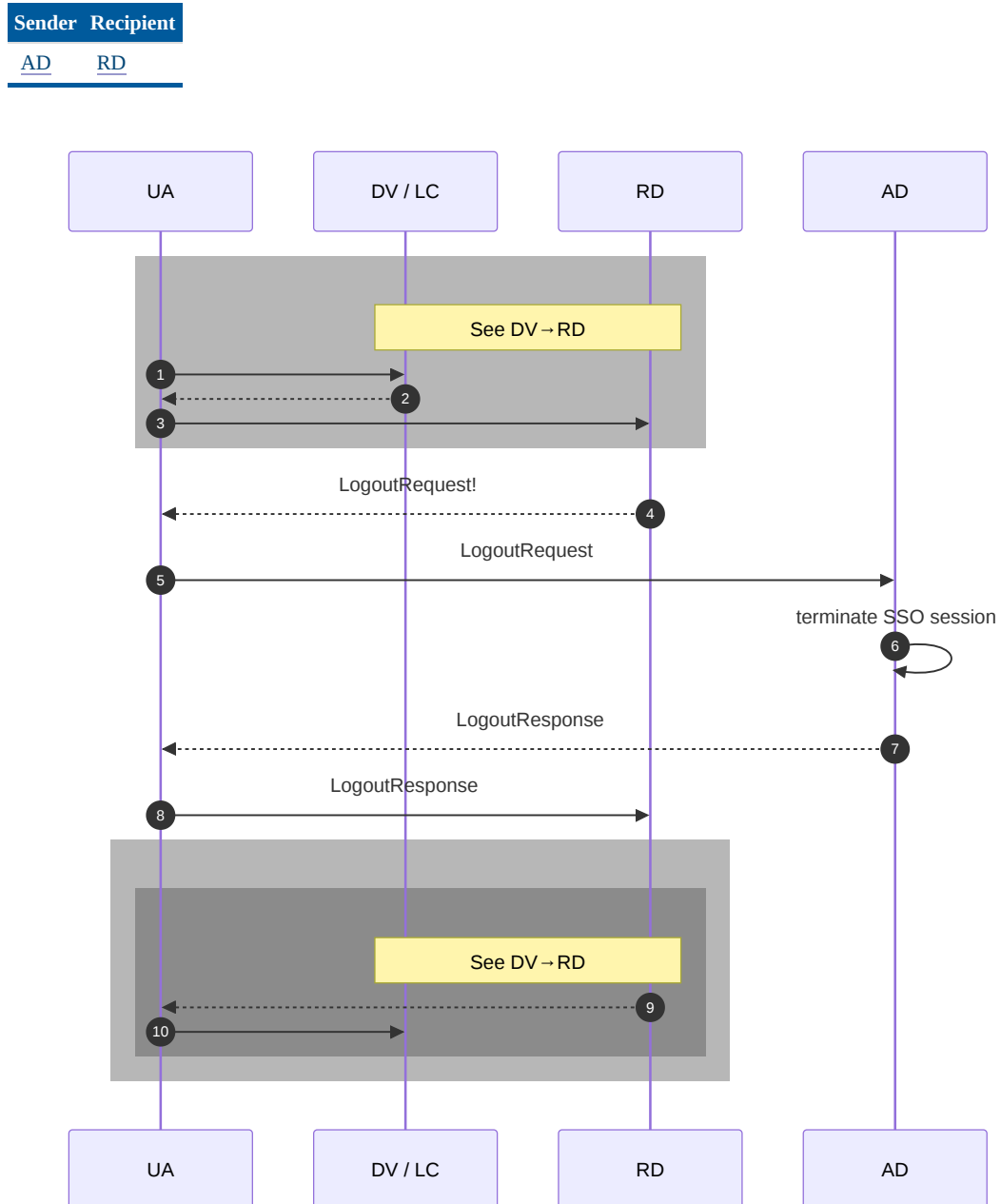

Figure 19 Logout Response RD -AD

### § 7.3.2.4 RD → AD logout Response - Message

An [AD](#) can send this Federated logout response message to the requesting [RD](#). The message is identical to [DV/LC → RD SAML Federated logout Response - Message](#)

## §7.4 Error messages

### § 7.4.1 Toplevel codes

The standard SAML 2.0 error codes are used. For error handling, conformity regarding the interpretation of the status codes as used in the [AuthN Response - Assertion](#) element is critical. The following top-level status codes *MAY* be used:

Status code	Description
<b><i>urn:oasis:names:tc:SAML:2.0:status:Requester</i></b>	This status code is used for errors caused by the initiator of the SAML request. For example, because an assurance level is requested which is not supported by the recipient, or because the request message has expired.
<b><i>urn:oasis:names:tc:SAML:2.0:status:Responder</i></b>	This status code is used for errors caused by the recipient of the SAML request. For example, because of technical failure or because the recipient does not support requested (optional) functionality.

### § 7.4.2 Second-level status codes

The following second-level status codes *MAY* be used:

Status code	Description
<b><i>urn:oasis:names:tc:SAML:2.0:status:AuthnFailed</i></b>	This status code is used when a user cannot be authenticated for example because invalid credentials have been provided or the cancel button has been used.
<b><i>urn:oasis:names:tc:SAML:2.0:status:NoAuthnContext</i></b>	This status code is used when a user cannot be authenticated at the minimum level as specified in the <a href="#">Service Catalog</a> .
<b><i>urn:oasis:names:tc:SAML:2.0:status:RequestUnsupported</i></b>	This status code is used when a message is correctly formatted by the requester, and understood by the recipient, but that functionality is requested which is not supported by the recipient.
<b><i>urn:oasis:names:tc:SAML:2.0:status:RequestDenied</i></b>	This status code is used when a SAML responder that refuses to perform a message exchange with the SAML requester, for example because a mandatory signature could not be verified.
<b><i>urn:oasis:names:tc:SAML:2.0:status:NoSupportedIDP</i></b>	Used to indicate that a <a href="#">RequesterID</a> is not supported by the intermediary.

### § 7.4.3 Cancelling

During the process of authenticating and authorizing, an [EU](#) may cancel the process by clicking on the cancel button.

If an [EU](#) cancels, the [Participant](#) *MUST* direct the [EU](#) automatically to the latest sender of a SAML request, accompanying a valid SAML [AuthN Response - StatusMessage](#) including valid SAML status codes ([urn:oasis:names:tc:SAML:2.0:status:Responder](#) with [urn:oasis:names:tc:SAML:2.0:status:AuthnFailed](#)). A [AuthN Response - StatusMessage](#) element *MUST* be included, containing the exact phrase Authentication cancelled.

If [RD](#) receives a cancellation message (from an [AD](#) or [BVD](#)), it *MUST* be forwarded to the [DV](#) or [LC](#).

If a [DV](#) or [LC](#) receives a cancellation message (from [RD](#)), it *MUST* indicate to the [EU](#) that he is not logged in, and *MAY* offer the [EU](#) the option to re-authenticate.

### § 7.4.4 Attributes not supported

A [Participant](#) can receive a message that matches the Interface specifications but cannot be processed by the recipient.

A [Participant](#) receiving such a message:

- *MUST* show the [EU](#) a message indicating that something went wrong (without revealing security sensitive details).
- *MAY* offer the [EU](#) the option to cancel, in that case the flow continues as stated in Cancelling.

### § 7.4.5 Incorrect message (recoverable)

A [Participant](#) can receive a message that matches the interface specifications but cannot be processed by the recipient. The recipient *MUST* direct the [EU](#) to initiator of the SAML request, accompanying a valid SAML [AuthN-response message](#) including valid SAML status codes ([urn:oasis:names:tc:SAML:2.0:status:Responder](#) with [urn:oasis:names:tc:SAML:2.0:status:RequestUnsupported](#)). A [AuthN Response - StatusMessage](#) element *MUST* be included, containing a description of the problem (for example "Level of assurance not supported").

A [Participant](#) receiving such a response:

1. *MUST* show the [EU](#) a [AuthN-response message](#) indicating authentication has failed, including the contents of [AuthN Response - StatusMessage](#).
2. If the [Participant](#) is a [RD](#) then the [RD](#) *MUST* ask the [EU](#) to re-select an [AD](#) or [BVD](#) or cancel. Except in case of [Use Case AD-preselection](#), then the [RD](#) *MUST* forward the [AuthN-response message](#) to the [DV](#) or [LC](#).

### § 7.4.6 Incorrect message (non-recoverable)

A [Participant](#) can receive an invalid formatted message. Examples:

- Not a valid SAML message
- XML does not match XSD

Alternatively, the message can be valid according to SAML specifications, but it does not match the Interface specifications. Examples:

- Unknown issuer
- Invalid NotOnOrAfter in [Authn Response Assertion](#) or [Authn Response Subject Confirmation](#)
- Invalid signature
- The [AuthN-request message](#) contains invalid attributes

- The [AuthN-response message](#) contains attributes or a [LoA](#) that does not match the [AuthN-request](#)

Such messages are the result of either an incorrect implementation by a [Participant](#), or an attempt to hack the system. The [EU](#) cannot always be send back to the requester, because the source of the message is unknown and/or cannot be trusted. If the message is an [AuthN-response message](#), it would not make sense to send the [EU](#) back to the responder.

A [Participant](#) that receives a [AuthN-response message](#) in this category

- *MUST* investigate the nature of the error.
- *MUST* show the [EU](#) a message indicating a non-recoverable error has occurred, advising the [EU](#) how to resolve the problem if possible, in case a binding is used where the [EU](#) is involved;
- *MUST* return a [AuthN-response message](#) with status codes ([urn:oasis:names:tc:SAML:2.0:status:Requester](#) and [urn:oasis:names:tc:SAML:2.0:status:RequestUnsupported](#)) or an HTTP error in case a binding is used where a synchronous response is expected and can be returned, like SOAP.

## §8. SAML Metadata

### §8.1 Metadata

Before a SAML connection can be established, the participants must provide each other with configuration data about the connection. This indicates which services, locations of services and certificates are used for the connection.

#### § 8.1.1 TLS certificates in metadata

For TLS certificates see technical requirements on [Signature](#) and on [Signing, encryption algorithms and hash functions](#)

#### § 8.1.2 General processing requirements

Processing requirements for the consuming parties:

- The metadata *MUST* be validated by the consuming parties
- The consuming parties *MUST NOT* use the metadata if the validation is not successful

### §8.2 DV Metadata

#### § 8.2.1 DV → RD Metadata

Published by	Consumed by
<a href="#">DV</a> that connects to <a href="#">RD</a> directly	<a href="#">RD</a>

This section describes the metadata that a [DV](#) with a direct connection to [RD](#) (not using a [LC](#)) must provide. This metadata *MAY* be published on a location known to [RD](#) or *MAY* be provided to [RD](#) by any other means supported.

See also [Example SAML-metadata DV for RD](#)

Element/@Attribute	0..n	Description
<i>EntityDescriptor</i>	1	The metadata <i>MUST</i> contain one <a href="#">EntityDescriptor</a> with one <a href="#">SPSSODescriptor</a> element.

Element/@Attribute	0..n	Description
<b>-@ID</b>	1	A document-unique identifier for the element, typically used as a reference point when signing.
<b>-@entityID</b>	1	Specifies the unique identifier of the SAML entity whose metadata is described by the element's contents. Contains the <a href="#">entityid</a> of the DV.
<b>-@validUntil</b>	0..1	<i>MAY</i> contain a datetime at which the metadata expires. If validUntil is expired, the metadata is considered invalid. Either validUntil or cacheDuration <i>MUST</i> be present. (following OASIS specification [ <a href="#">SAML2.METADATA</a> ])
<b>-@cacheDuration</b>	0..1	<i>MAY</i> contain cacheduration. Every <a href="#">Participant</a> is advised to check for new <a href="#">Metadata</a> after the given period. Either validUntil or cacheDuration <i>MUST</i> be present. (following OASIS specification [ <a href="#">SAML2.METADATA</a> ])
<b>-Signature</b>	1	<i>MUST</i> contain the Digital signature of the <a href="#">DV</a> to verify the integrity of this <a href="#">Metadata</a> and <i>MUST</i> be generated with a (private signing key associated with a) PKIOverheid public-key certificate which contains the same <a href="#">QJN</a> as used in the <a href="#">entityID</a> . Also see technical requirements on <a href="#">Signature</a> and on <a href="#">Signing, encryption algorithms and hash functions</a>
<b>-SPSSODescriptor</b>	1	
<b>--@AuthnRequestsSigned</b>	1	<i>MUST</i> be set to true.
<b>--@protocolSupportEnumeration</b>	1	<i>MUST</i> be set to urn:oasis:names:tc:SAML:2.0:protocol
<b>--@WantAssertionsSigned</b>	1	<i>MUST</i> be set to true.
<b>--KeyDescriptor</b>	2..n	<i>MUST</i> contain <a href="#">KeyDescriptor</a> element(s) that allow for signing of SAML messages and authenticating a TLS connection. This can be achieved by inclusion of 2 <a href="#">KeyDescriptor</a> element with @use="signing" or a single certificate with @use="signing" that supports both functions. A second <a href="#">KeyDescriptor</a> <i>MAY</i> be present for both of these keys to support certificate rollover. SAML message signing and TLS functions <i>MAY</i> be combined in a single certificate or in separate certificates. <i>MUST</i> contain at least 1 <a href="#">KeyDescriptor</a> element that supports encryption (@use="encryption"). A second <a href="#">KeyDescriptor</a> with @use="encryption" <i>MAY</i> be present to support certificate rollover. Also see technical requirements on <a href="#">Signing, encryption algorithms and hash functions</a>
<b>---KeyInfo</b>	1	
<b>----KeyName</b>	1	Contains the name which identifies the key.
<b>----X509Data</b>	1	Contains the encoded PKIOverheid X509 certificate with the public key.
<b>--SingleLogoutService</b>	0..n	Conditional: <i>MUST</i> be present if the DV supports <a href="#">SSO</a> . Describes the endpoint used to log the <a href="#">EU</a> out of its current session if participating in a SSO session.
<b>---@Binding</b>	1	<i>MUST</i> contain the appropriate binding for the endpoint. The binding parameter denotes the type of binding used. This is an urn relating to [ <a href="#">SAML2.BINDINGS</a> ]. At least one <a href="#">SingleLogoutService</a> <i>MUST</i> contain the HTTP-POST binding.
<b>---@Location</b>	1	<i>MUST</i> contain the URL of the <a href="#">SingleLogoutService</a> endpoint for the <a href="#">Binding</a> .
<b>--AssertionConsumerService</b>	1..n	Must contain at least one URL to which the <a href="#">EU</a> will be redirected after authentication. If more than one is included one <i>MUST</i> contain the attribute @isDefault with value true.
<b>--AttributeConsumingService</b>	0..n	Conditional: <i>MUST</i> be present when <a href="#">DV</a> uses a corresponding <a href="#">AttributeConsumingServiceIndex</a> in the <a href="#">DV AuthnRequest Message</a> . <i>MUST NOT</i> be present in any other case or by any other <a href="#">Participant</a> role.  When used, AttributeConsumingService <i>MUST</i> contain 1 or more elements that describe the <a href="#">Service</a> requested using an <a href="#">@Index</a> to a <a href="#">Service Definition</a> registered with <a href="#">Service Catalog</a> kept by <a href="#">RD</a> .

Element/@Attribute	0..n	Description
<b>---@Index</b>	1	<i>MUST</i> be present.
<b>---@isDefault</b>	0..1	<i>MUST</i> be present if more than one <a href="#">Index</a> is specified in the metadata. <i>MAY</i> only be present once. If present indicates the default <a href="#">AttributeConsumingService</a> which is used when no <a href="#">AttributeConsumingServiceIndex</a> was referenced in the <a href="#">AuthN Request Message</a> . It is advised to always include an <a href="#">AttributeConsumingServiceIndex</a> in the <a href="#">AuthN Request Message</a> .
<b>---ServiceName</b>	1..n	One or more language-qualified names for the service. Only one descriptor per language <i>MUST</i> be present.
<b>---RequestedAttribute</b>	1..n	At least one <a href="#">RequestedAttribute</a> element <i>MUST</i> be present with @name="urn:n1-eid-gdi:1.0:ServiceUUID".
<b>---AttributeValue</b>	1	<i>MUST</i> contain the ServiceUUID to be used for this authentication. The <a href="#">ServiceUUID</a> must be pre-registered with <a href="#">Service Catalog</a> kept by <a href="#">RD</a> .

### § 8.2.2 LC → RD metadata

Published by	Consumed by
<a href="#">LC</a>	<a href="#">RD</a>

This section describes the metadata the [LC](#) publishes for the RD. The LC *MUST* provide the metadata for each [DV](#) it supports. The metadata *MUST* be signed by the [LC](#). The metadata of all [DVs](#) using an [LC](#) *MUST* be supplied as a single file and *MAY* additionally be supplied as individual files.

This section describes the layout of the metadata. The XML schema for the Metadata is that of [[SAML2.METADATA](#)].

See also [Example SAML-metadata LC for RD](#)

Element/@Attribute	0..n	Description
<b>EntitiesDescriptor</b>	1	Required element to start metadata containing multiple <a href="#">EntityDescriptors</a> .
<b>-@ID</b>	1	A document-unique identifier for the element, typically used as a reference point when signing.
<b>-@validUntil</b>	0..1	<i>MAY</i> contain a datetime at which the metadata expires. If <a href="#">validUntil</a> is expired, the metadata is considered invalid. Either <a href="#">validUntil</a> or <a href="#">cacheDuration</a> <i>MUST</i> be present. (following OASIS specification [ <a href="#">SAML2.METADATA</a> ]).
<b>-@cacheDuration</b>	0..1	<i>MAY</i> contain cache duration. Consumers are advised to check for new metadata after the given period. Either <a href="#">validUntil</a> or <a href="#">cacheDuration</a> <i>MUST</i> be present. (following OASIS specification [ <a href="#">SAML2.METADATA</a> ]).
<b>-Signature</b>	1	<i>MUST</i> contain the Digital signature of the <a href="#">LC</a> to verify the integrity of this <a href="#">Metadata</a> and <i>MUST</i> be generated with a (private signing key associated with a) PKI-overheid public-key certificate which contains the same <a href="#">QIN</a> as used in the <a href="#">entityID</a> . Also see technical requirements on <a href="#">Signature</a> and on <a href="#">Signing, encryption algorithms and hash functions</a>
<b>-EntityDescriptor</b>	1..n	<i>MUST</i> contain the <a href="#">EntityDescriptor</a> of the <a href="#">LC</a> , see <a href="#">LC EntityDescriptor</a> . <i>MUST</i> contain the <a href="#">EntityDescriptors</a> of all <a href="#">DV</a> 's the <a href="#">LC</a> supports, see <a href="#">DV EntityDescriptor</a> .

#### § 8.2.2.1 LC → RD EntityDescriptor

Element/@Attribute	0..n	Description
<b>@ID</b>	1	A document-unique identifier for the element, typically used as a reference point when signing.
<b>@entityID</b>	1	<i>MUST</i> contain the <a href="#">entityid</a> of the <a href="#">LC</a> .
<b>@validUntil</b>	0..1	<i>SHOULD NOT</i> be used as either <a href="#">validUntil</a> or <a href="#">cacheDuration</a> is already present at <a href="#">EntitiesDescriptor</a> level.

Element/@Attribute	0..n	Description
		<i>MAY</i> contain a datetime at which the metadata expires. If <code>validUntil</code> is expired, the metadata is considered invalid.
<code>@cacheDuration</code>	0..1	<i>SHOULD NOT</i> be used as either <code>validUntil</code> or <code>cacheDuration</code> is already present at <code>EntitiesDescriptor</code> level. <i>MAY</i> contain <code>cacheduration</code> . <i>RD</i> is advised to check for new metadata after the given period.
<code>@Signature</code>	0..1	<i>SHOULD NOT</i> be used as the metadata is already signed at the <code>EntitiesDescriptor</code> level. If used it <i>MUST</i> be generated with the private signing key with an associated PKI overhead public-key certificate which contains the same <code>OID</code> as the <code>entityid</code> in the <code>EntityDescriptor</code> .
<code>@SPSSODescriptor</code>	1	The <code>SPSSODescriptor</code> implements profiles specific to service providers.
<code>-@AuthnRequestsSigned</code>	1	Must be set to <code>true</code> .
<code>-@WantAssertionsSigned</code>	1	Must be set to <code>true</code> .
<code>-@protocolSupportEnumeration</code>	1	<i>MUST</i> be set to: <code>urn:oasis:names:tc:SAML:2.0:protocol</code> .
<code>-KeyDescriptor</code>	1..4	<i>MUST</i> contain <code>KeyDescriptor</code> element(s) that allow for signing of SAML messages and authenticating a TLS connection. This can be achieved by inclusion of 2 <code>KeyDescriptor</code> element with <code>@use="signing"</code> or a single certificate with <code>@use="signing"</code> that supports both functions. A second <code>KeyDescriptor</code> <i>MAY</i> be present for both of these keys to support certificate rollover. SAML message signing and TLS functions <i>MAY</i> be combined in a single certificate or in separate certificates.  <i>NOTE:</i> Also see technical requirements on <a href="#">Signing, encryption algorithms and hash functions</a>
<code>--KeyInfo</code>	1	
<code>--KeyName</code>	1	Contains the name which identifies the key. <i>MAY</i> be any string. Common practice is using the SHA1 fingerprint stripped of colons.
<code>---X509Data</code>	1	Contains the encoded X509 certificate with the public key.
<code>-SingleLogoutService</code>	0..n	Conditional: <i>MUST</i> be present if the LC supports <i>SSO</i> . Describes the endpoint used to log the <i>EU</i> out of its current session if participating in a <i>SSO</i> session.
<code>--@Binding</code>	1	<i>MUST</i> contain the appropriate binding for the endpoint. The binding parameter denotes the type of binding used. This is a urn relating to [ <i>SAML2.BINDINGS</i> ]. At least one <code>SingleLogoutService</code> <i>MUST</i> contain the HTTP-POST binding.
<code>--@Location</code>	1	<i>MUST</i> contain the URL of the <code>SingleLogoutService</code> endpoint for the <code>@Binding</code> .
<code>-AssertionConsumerService</code>	1..n	Must contain at least one URL to which the <i>EU</i> will be redirected after authentication.
<code>--@Binding</code>	1	The binding parameter denotes the type of binding used. This is a urn relating to [ <i>SAML2.BINDINGS</i> ] At least one <code>AssertionConsumerService</code> binding <i>MUST</i> be set to <code>urn:oasis:names:tc:SAML:2.0:bindings:HTTP-Artifact</code> . Other bindings are NOT supported.
<code>--@Location</code>	1	The URL of the SAML endpoint
<code>--@Index</code>	1	The index of the binding, <i>MUST</i> be unique for all <code>AssertionConsumerService</code> elements.
<code>--@isDefault</code>	0..1	If more than one <code>AssertionConsumerService</code> elements are included, one of these elements <i>MUST</i> be flagged as default by setting the <code>isDefault</code> XML attribute with value <code>true</code> .

### § 8.2.2.2 DV → RD *EntityDescriptor*

For each [DV](#) supported by an [LC](#) the following metadata must be included in the [LC](#) metadata.

Element/@Attribute	0..n	Description
<b>@ID</b>	1	A document-unique identifier for the element, typically used as a reference point when signing.
<b>@entityID</b>	1	Specifies the unique identifier of the SAML entity whose metadata is described by the element's contents. <i>MUST</i> contain the <a href="#">entityid</a> of the <a href="#">DV</a> . <i>SHOULD NOT</i> be used as either <a href="#">validUntil</a> or <a href="#">cacheDuration</a> is already present at <a href="#">EntitiesDescriptor</a> level.
<b>@validUntil</b>	0..1	<i>MAY</i> contain a datetime at which the metadata expires. If <a href="#">validUntil</a> is expired, the metadata is considered invalid.
<b>@cacheDuration</b>	0..1	<i>SHOULD NOT</i> be used as either <a href="#">validUntil</a> or <a href="#">cacheDuration</a> is already present at <a href="#">EntitiesDescriptor</a> level. <i>MAY</i> contain <a href="#">cacheduration</a> . <a href="#">RD</a> is advised to check for new metadata after the given period.
<b>Signature</b>	0..1	<i>SHOULD NOT</i> be used as the metadata is already signed at the <a href="#">EntitiesDescriptor</a> level. If used it <i>MUST</i> be generated with the private signing key with an associates PKIoverheid public-key certificate which contains the same <a href="#">QIN</a> as the <a href="#">entityid</a> in the <a href="#">DV EntityDescriptor</a> . The public key certificate <i>MUST</i> be present in the <a href="#">KeyDescriptor</a> metadata. <i>MUST</i> contain a <a href="#">KeyInfo</a> element with a <a href="#">KeyName</a> or <a href="#">X509Certificate</a> elements.
<b>SPSSODescriptor</b>	1	
<b>@-@protocolSupportEnumeration</b>	1	Set to: urn:oasis:names:tc:SAML:2.0:protocol.
<b>-KeyDescriptor</b>	1..2	<i>MUST</i> contain at least 1 <a href="#">KeyDescriptor</a> element that supports encryption (@use="encryption"). A second <a href="#">KeyDescriptor</a> with @use="encryption" <i>MAY</i> be present to support certificate rollover. Also see technical requirements on <a href="#">Signing, encryption algorithms and hash functions</a>
<b>--KeyInfo</b>	1	
<b>---KeyName</b>	1	Contains the name which identifies the key. <i>MAY</i> be any string. Common practice is using the SHA1 fingerprint stripped of colons.
<b>---X509Data</b>	1	Contains the encoded X509 certificate with the public key.
<b>-AssertionConsumerService</b>	1..n	According to <a href="#">saml-metadata-2.0</a> <i>MUST</i> contain at least one URL to which the <a href="#">EU</a> will be redirected after authentication. <i>MUST</i> contain only one entry. <i>MUST</i> contain a copy of the <a href="#">AssertionConsumerService</a> element in the <a href="#">LC</a> 's <a href="#">EntityDescriptor</a> . This entry will be ignored as the <a href="#">AssertionConsumerService</a> definitions in the <a href="#">LC EntityDescriptor</a> <i>MUST</i> be used.

### § 8.2.3 RD → DV/LC metadata

Published by	Consumed by
<a href="#">RD</a>	<a href="#">DV</a> that connect directly with <a href="#">RD</a> , <a href="#">LC</a>

[RD](#) publishes metadata in accordance with [[SAML2.METADATA](#)] with one [EntityDescriptor](#) element. The metadata is signed in accordance with the SAML signature.

See also [Example SAML-metadata a RD for DV](#)

Element/@Attribute	0..n	Description
<b>EntityDescriptor</b>	1	
<b>-@ID</b>	1	A document-unique identifier for the element, typically used as a reference point when signing.
<b>-@entityID</b>	1	Specifies the unique identifier of the SAML entity whose metadata is described by the element's contents. Contains the <a href="#">entityid</a> of RD.
<b>-@validUntil</b>	0..1	<i>MAY</i> contain a datetime at which the metadata expires. If <a href="#">validUntil</a> is expired, the metadata is considered invalid. Either <a href="#">validUntil</a> or <a href="#">cacheDuration</a> <i>MUST</i> be present. (following OASIS specification [ <a href="#">SAML2.METADATA</a> ])
<b>-@cacheDuration</b>	0..1	<i>MAY</i> contain cache duration. DV or LC is advised to check for new metadata after the given period. Either <a href="#">validUntil</a> or <a href="#">cacheDuration</a> <i>MUST</i> be present. (following OASIS specification [ <a href="#">SAML2.METADATA</a> ])
<b>-Signature</b>	1	<i>MUST</i> contain the Digital signature of the <a href="#">RD</a> to verify the integrity of this <a href="#">Metadata</a> and <i>MUST</i> be generated with a (private signing key associated with a) PKIoverheid public-key certificate which contains the same <a href="#">QIN</a> as used in the <a href="#">entityID</a> . Also see technical requirements on <a href="#">Signature</a> and on <a href="#">Signing, encryption algorithms and hash functions</a>
<b>-IDPSSODescriptor</b>	1	
<b>--@protocolSupportEnumeration</b>	1	Set to: urn:oasis:names:tc:SAML:2.0:protocol
<b>--@WantAuthnRequestsSigned</b>	1	Set to true indication that AuthnRequest messages <i>MUST</i> be signed by the <a href="#">DV</a> or <a href="#">LC</a> .
<b>--KeyDescriptor</b>	1..n	Contains at least 1 KeyDescriptor element with @use="signing"
<b>---KeyInfo</b>	1	
<b>----KeyName</b>	1	Contains the name which identifies the key.
<b>----X509Data</b>	1	Contains the encoded X509 certificate with the public key.
<b>--ArtifactResolutionService</b>	1..n	The ArtifactResolutionService <i>MUST</i> be implemented at least once per service.
<b>---@Binding</b>	1	The binding parameter denotes the type of binding used. In the <a href="#">ArtifactResolutionService</a> this is the SAML-SOAP binding only. The value of this attribute is a urn relating to [ <a href="#">SAML2.BINDINGS</a> ].
<b>---@Location</b>	1	The URL of the SAML artifact resolution endpoint
<b>---@Index</b>	1	The index of the binding, <i>MUST</i> be unique for all <a href="#">ArtifactResolutionService</a> elements
<b>--SingleSignOnService</b>	1..n	One or more elements of type EndpointType that describe endpoints that support the profiles of the Authentication Request protocol defined in [ <a href="#">SAML2.PROFILES</a> ].
<b>---@Binding</b>	1	The binding parameter denotes the type of binding used. In the <a href="#">SingleSignOnService</a> this is the HTTP-POST binding only. The value of this attribute is an urn relating to [ <a href="#">SAML2.BINDINGS</a> ].
<b>---@Location</b>	1	The URL of the SAML <a href="#">SingleSignOnService</a> endpoint
<b>--SingleLogoutService</b>	1..n	Describes the endpoint used to log the <a href="#">EU</a> out of its current session if participating in a <a href="#">SSO</a> session.
<b>---@Binding</b>	1	<i>MUST</i> be set to urn:oasis:names:tc:SAML:2.0:bindings:HTTP-POST. Other bindings are NOT supported.
<b>---@Location</b>	1	The URL of the SAML endpoint

## §8.3 RD metadata

### § 8.3.1 RD → AD metadata

#### Published by Consumed by

RD AD , BVD

This section describes the [Metadata](#) the [RD](#) publishes for the [AD/BVD](#) (acting as the SAML-role of a [DV](#)). The [RD](#) *MUST* provide the [Metadata](#) for each [DV](#) it supports. The [Metadata](#) *MUST* be signed by the [RD](#). The [Metadata](#) of all [DV](#)s using an [RD](#) *MUST* be supplied as a single file and *MAY* additionally be supplied as individual files.

This section describes the layout of the metadata. The XML schema for the Metadata is that of [[SAML2.METADATA](#)].

See also [Example SAML-metadata RD for AD/BVD](#)

Element/@Attribute	0..n	Description
<b>EntitiesDescriptor</b>	1	Required element to start metadata containing multiple <a href="#">EntityDescriptors</a> .
<b>-@ID</b>	1	A document-unique identifier for the element, typically used as a reference point when signing.
<b>-@validUntil</b>	1	Contains a datetime at which the metadata expires. If <a href="#">validUntil</a> is expired, the metadata is considered invalid. This element <i>MUST</i> be present. (following OASIS specification [ <a href="#">SAML2.METADATA</a> ]).
<b>-Signature</b>	1	<i>MUST</i> contain the Digital signature of the <a href="#">RD</a> to verify the integrity of this <a href="#">Metadata</a> and <i>MUST</i> be generated with a (private signing key associated with a) PKIoverhead public-key certificate which contains the same <a href="#">QIN</a> as used in the <a href="#">entityID</a> . Also see technical requirements on <a href="#">Signature</a> and on <a href="#">Signing, encryption algorithms and hash functions</a>
<b>-EntityDescriptor</b>	1..n	<i>MUST</i> contain the <a href="#">EntityDescriptor</a> of the <a href="#">RD</a> (see <a href="#">EntityDescriptor</a> ). <i>MUST</i> contain the <a href="#">EntityDescriptors</a> of all <a href="#">DV</a> 's the <a href="#">RD</a> supports (see <a href="#">EntityDescriptors</a> ).

#### § 8.3.1.1 EntityDescriptor

Element/@Attribute	0..n	Description
<b>@ID</b>	1	A document-unique identifier for the element, typically used as a reference point when signing.
<b>@entityID</b>	1	<i>MUST</i> contain the entityID of the <a href="#">RD</a> .
<b>@validUntil</b>	0..1	<i>SHOULD NOT</i> be used as <a href="#">validUntil</a> is already present at <a href="#">EntitiesDescriptor</a> level. <i>MAY</i> contain a datetime at which the metadata expires. If <a href="#">validUntil</a> is expired, the metadata is considered invalid.
<b>Signature</b>	0..1	<i>SHOULD NOT</i> be used as the metadata is already signed at the <a href="#">EntitiesDescriptor</a> level. If used it <i>MUST</i> be generated with the private signing key with an associated PKIoverhead public-key certificate which contains the same <a href="#">QIN</a> as used in the <a href="#">entityID</a> .
<b>SPSSODescriptor</b>	1	The <a href="#">SPSSODescriptor</a> implements profiles specific to service providers.
<b>-@AuthnRequestsSigned</b>	1	Must be set to true.
<b>-@WantAssertionsSigned</b>	1	Must be set to true.
<b>-@protocolSupportEnumeration</b>	1	<i>MUST</i> be set to: urn:oasis:names:tc:SAML:2.0:protocol.
<b>-KeyDescriptor</b>	1..4	<i>MUST</i> contain <a href="#">KeyDescriptor</a> element(s) that allow for signing of SAML messages and authenticating a TLS connection. This can be achieved by inclusion of 2 <a href="#">KeyDescriptor</a> element with <a href="#">@use="signing"</a> or a single certificate with <a href="#">@use="signing"</a> that supports both functions. A second

Element/@Attribute	0..n	Description
		<p><a href="#">KeyDescriptor</a> <i>MAY</i> be present for both of these keys to support certificate rollover. SAML message signing and TLS functions <i>MAY</i> be combined in a single certificate or in separate certificates.</p> <p><i>MUST</i> contain at least 1 <a href="#">KeyDescriptor</a> element that supports encryption (@use="encryption"). A second <a href="#">KeyDescriptor</a> with @use="encryption" <i>MAY</i> be present to support certificate rollover.</p> <p>Also see technical requirements on <a href="#">Signing, encryption algorithms and hash functions</a></p>
--KeyInfo	1	
---KeyName	1	Contains the name which identifies the key. <i>MAY</i> be any string. Common practice is using the SHA1 fingerprint stripped of colons.
---X509Data	1	Contains the encoded X509 certificate with the public key.
-SingleLogoutService	0..n	Conditional: <i>MUST</i> be present if the <a href="#">RD</a> supports <a href="#">SSO</a> . Describes the endpoint used to log the <a href="#">EU</a> out of its current session if participating in a <a href="#">SSO</a> session.
--@Binding	1	<i>MUST</i> contain the appropriate binding for the endpoint. The binding parameter denotes the type of binding used. This is a urn relating to [ <a href="#">SAML2.BINDINGS</a> ]. At least one <a href="#">SingleLogoutService</a> <i>MUST</i> contain the HTTP-POST binding.
--@Location	1	<i>MUST</i> contain the URL of the <a href="#">SingleLogoutService</a> endpoint for the <a href="#">@Binding</a> .
-AssertionConsumerService	1..n	<i>MUST</i> contain at least one URL to which the <a href="#">EU</a> will be redirected after authentication.
--@Binding	1	The binding parameter denotes the type of binding used. This is a urn relating to [ <a href="#">SAML2.BINDINGS</a> ] At least one <a href="#">AssertionConsumerService</a> binding <i>MUST</i> be set to urn:oasis:names:tc:SAML:2.0:bindings:HTTP-Artifact. Other bindings are NOT supported.
--@Location	1	The URL of the SAML endpoint
--@Index	1	The index of the binding, <i>MUST</i> be unique for all <a href="#">AssertionConsumerService</a> elements.
--@isDefault	0..1	If more than one <a href="#">AssertionConsumerService</a> elements are included, one of these elements <i>MUST</i> be flagged as default by setting the isDefault XML attribute with value true.

### § 8.3.1.2 DV → AD *EntityDescriptor*

For each [DV](#) supported by an [RD](#) the following metadata must be included in the [RD](#) metadata.

Element/@Attribute	0..n	Description
@ID	1	A document-unique identifier for the element, typically used as a reference point when signing.
@entityID	1	Specifies the unique identifier of the SAML entity whose metadata is described by the element's contents. <i>MUST</i> contain the <a href="#">entityid</a> of the <a href="#">DV</a> .
@validUntil	0..1	<i>SHOULD NOT</i> be used as <a href="#">validUntil</a> is already present at <a href="#">EntitiesDescriptor</a> level. <i>MAY</i> contain a datetime at which the metadata expires. If <a href="#">validUntil</a> is expired, the metadata is considered invalid.
@cacheDuration	0..1	<i>SHOULD NOT</i> be used as <a href="#">validUntil</a> is already present at <a href="#">EntitiesDescriptor</a> level. <i>MAY</i> contain cacheduration. <a href="#">AD</a> is advised to check for new metadata after the given period.

Element/@Attribute	0..n	Description
<b>Signature</b>	0..1	<i>SHOULD NOT</i> be used as the metadata is already signed at the <a href="#">EntitiesDescriptor</a> level. If used it <i>MUST</i> be generated with the private signing key with an associates PKIOverhead public-key certificate which contains the same <a href="#">QIN</a> as the <a href="#">entityid</a> in the DV <a href="#">EntityDescriptor</a> . The public key certificate <i>MUST</i> be present in the KeyDescriptor metadata. <i>MUST</i> contain a KeyInfo element with a KeyName or X509Certificate elements.
<b>SPSSODescriptor</b>	1	
<b>-@protocolSupportEnumeration</b>	1	Set to: urn:oasis:names:tc:SAML:2.0:protocol.
<b>-KeyDescriptor</b>	1..2	<i>MUST</i> contain at least 1 <a href="#">KeyDescriptor</a> element that supports encryption (@use="encryption"). A second <a href="#">KeyDescriptor</a> with @use="encryption" <i>MAY</i> be present to support certificate rollover. Also see technical requirements on <a href="#">Signing, encryption algorithms and hash functions</a>
<b>--KeyInfo</b>	1	
<b>---KeyName</b>	1	Contains the name which identifies the key. <i>MAY</i> be any string. Common practice is using the SHA1 fingerprint stripped of colons.
<b>---X509Data</b>	1	Contains the encoded X509 certificate with the public key.
<b>-AssertionConsumerService</b>	1..n	According to saml-metadata-2.0 <i>MUST</i> contain at least one URL to which the <a href="#">EU</a> will be redirected after authentication. <i>MUST</i> contain only one entry. <i>MUST</i> contain a copy of the <a href="#">AssertionConsumerService</a> element in the RD's <a href="#">EntityDescriptor</a> . This entry will be ignored as the <a href="#">AssertionConsumerService</a> definitions in the RD <a href="#">EntityDescriptor</a> <i>MUST</i> be used.

### § 8.3.2 AD/BVD → RD metadata

Published by	Consumed by
<a href="#">AD, BVD</a>	<a href="#">RD</a>

An AD/BVD publishes metadata in accordance with [[SAML2.METADATA](#)] with one [EntityDescriptor](#) element. The metadata is signed in accordance with the SAML signature.

Element/@Attribute	0..n	Description
<b>EntityDescriptor</b>	1	
<b>-@ID</b>	1	A document-unique identifier for the element, typically used as a reference point when signing.
<b>-@entityID</b>	1	Specifies the unique identifier of the SAML entity whose metadata is described by the element's contents. Contains the <a href="#">entityid</a> of the <a href="#">AD/BVD</a> .
<b>-@validUntil</b>	1	Contains a datetime at which the metadata expires. If <a href="#">validUntil</a> is expired, the metadata is considered invalid. This element <i>MUST</i> be present. (following OASIS specification [ <a href="#">SAML2.METADATA</a> ]).
<b>-Signature</b>	1	<i>MUST</i> contain the Digital signature of the <a href="#">AD</a> to verify the integrity of this <a href="#">Metadata</a> and <i>MUST</i> be generated with a (private signing key associated with a) PKIOverhead public-key certificate which contains the same <a href="#">QIN</a> as used in the <a href="#">entityID</a> . Also see technical requirements on <a href="#">Signature</a> and on <a href="#">Signing, encryption algorithms and hash functions</a>
<b>-IDPSSODescriptor</b>	1	
<b>--@protocolSupportEnumeration</b>	1	Set to: urn:oasis:names:tc:SAML:2.0:protocol
<b>--@WantAuthnRequestsSigned</b>	1	Set to true indication that AuthnRequest messages <i>MUST</i> be signed by the <a href="#">RD</a> .
<b>--KeyDescriptor</b>	1..n	Contains at least 1 KeyDescriptor element with @use="signing". A <a href="#">BVD</a> <i>MUST</i> also provide at least 1 <a href="#">KeyDescriptor</a> element that supports

Element/@Attribute	0..n	Description
		encryption (@use="encryption") for receiving ActingSubjectID (see <a href="#">Attribute</a> ) with an EncryptedID's from an <a href="#">AD</a> . A second <a href="#">KeyDescriptor</a> with @use="encryption" <i>MAY</i> be present to support certificate rollover. Also see technical requirements on <a href="#">Signing, encryption algorithms and hash functions</a>
<b>---KeyInfo</b>	1	
<b>----KeyName</b>	1	Contains the name which identifies the key.
<b>----X509Data</b>	1	Contains the encoded X509 certificate with the public key.
<b>--ArtifactResolutionService</b>	1..n	The <a href="#">ArtifactResolutionService</a> <i>MUST</i> be implemented at least once per service.
<b>---@Binding</b>	1	The binding parameter denotes the type of binding used. In the <a href="#">ArtifactResolutionService</a> this is the SAML-SOAP binding only. The value of this attribute is a urn relating to [ <a href="#">SAML2.BINDINGS</a> ].
<b>---@Location</b>	1	The URL of the SAML artifact resolution endpoint
<b>---@Index</b>	1	The index of the binding, <i>MUST</i> be unique for all <a href="#">ArtifactResolutionService</a> elements
<b>--SingleSignOnService</b>	1..n	One or more elements of type <a href="#">EndpointType</a> that describe endpoints that support the profiles of the Authentication Request protocol defined in [ <a href="#">SAML2.PROFILES</a> ].
<b>---@Binding</b>	1	The binding parameter denotes the type of binding used. In the <a href="#">SingleSignOnService</a> this is the HTTP-POST binding only. The value of this attribute is an urn relating to [ <a href="#">SAML2.BINDINGS</a> ].
<b>---@Location</b>	1	The URL of the SAML <a href="#">SingleSignOnService</a> endpoint
<b>--SingleLogoutService</b>	0..1	<i>MUST</i> be present if the <a href="#">AD</a> supports <a href="#">SSO</a> . <i>MUST NOT</i> be present in the metadata of the BVD. Describes the endpoint used to log the <a href="#">EU</a> out of its current session if participating in a <a href="#">SSO</a> session.
<b>---@Binding</b>	1	<i>MUST</i> be set to urn:oasis:names:tc:SAML:2.0:bindings:HTTP-POST. Other bindings are NOT supported.
<b>---@Location</b>	1	The URL of the SAML endpoint

## §9. Technical requirements and recommendations

### §9.1 Signing, encryption algorithms and hash functions

[ST-SAML](#) does not support SHA1 except for the padding function (xmldsig # rsa-sha1). Only RSA is supported for signing as PKIOverheid certificates do not support other methods. For signing, the following list of signing algorithms is supported:

Signing algorithm	urn
RSAwithSHA256	<a href="http://www.w3.org/2001/04/xmldsig-more#rsa-sha256">http://www.w3.org/2001/04/xmldsig-more#rsa-sha256</a>
RSAwithSHA384	<a href="http://www.w3.org/2001/04/xmldsig-more#rsa-sha384">http://www.w3.org/2001/04/xmldsig-more#rsa-sha384</a>
RSAwithSHA512	<a href="http://www.w3.org/2001/04/xmldsig-more#rsa-sha512">http://www.w3.org/2001/04/xmldsig-more#rsa-sha512</a>

(source: [[XML.SIG](#)] § 6.1)

At minimum, SHA256 must be used to calculate the message digest (<ds:DigestMethod Algorithm = "http://www.w3.org/2001/04/xmenc#sha256" />).

Digest algorithm	urn
SHA256	<a href="http://www.w3.org/2001/04/xmenc#sha256">http://www.w3.org/2001/04/xmenc#sha256</a>
SHA384	<a href="http://www.w3.org/2001/04/xmldsig-more#sha384">http://www.w3.org/2001/04/xmldsig-more#sha384</a>
SHA512	<a href="http://www.w3.org/2001/04/xmenc#sha512">http://www.w3.org/2001/04/xmenc#sha512</a>

(source: [[XML.SIG](#)] § 6.1)

All SAML messages that must be signed, must be signed with an Enveloped Signature Transform  
<http://www.w3.org/TR/2013/REC-xmldsig-core1-20130411/#enveloped-signature>

[Participants](#) are required to fully check signatures and associated messages according to standards including checking the correctness of the sender. This also applies to [Metadata](#).

To guarantee authenticity, integrity and non-repudiation, each message described *MUST* be provided with a digital signature from the message sender. The message recipient *MUST* validate all of the digital signatures - except signatures in an Assertion/Advice as they are intended for evidence - in the message before processing it according to the processing rules required by PKIOverhead per Certificate Practice Statements (CPS) including checking the validity of the certificate.

- The recipient *MUST* check that the message is signed with a valid digital signature that envelopes the whole message with Enveloped Signature Transform.
- The recipient *MUST NOT* process the message if signature validation fails.

The following requirements apply to generating digital signatures:

- The digital signature is embedded in the message content with Enveloped Signature Transform  
<http://www.w3.org/2000/09/xmldsig#enveloped-signature>.
- Canonicalization *MUST* be carried out according to the exclusive c14n method without comments, as identified by <http://www.w3.org/2001/10/xml-exc-c14n#> (see [[XML.C14N.EXCL](#)])
- Digests *MUST* be calculated with at minimum the SHA256 algorithm except for the fore mentioned exception (padding with SHA1).
- The SignatureValue *MUST* be calculated with at minimum the RSAwithSHA256 algorithm.
- a [Participant](#) *MUST* sign messages and metadata with a PKIOverhead certificate with a key length of at least 2048 bits, and which contains the [QID](#) of the [Participant](#). PKIOverhead TLS certificates can be included as a signing certificate (in saml [Metadata](#)). Difference with normal signing certificate can be made via extended key usage. See [[SAML2.ERRATA.05](#)], E62. So the (extended) key usage of the certificate *MUST* allow use for signing.
- The Reference *MUST* refer to the signed element via an ID attribute in the local document, as per the signature profile of [[SAML2.CORE](#)] (§ 5.4) and [[SAML2.METADATA](#)] (§ 3.1).

## §9.2 Signature

Each Signature element in SAML messages generated by a [DV](#) or [LC](#) (see [Signature](#) in [DV AuthN-request message](#)) and in the [DV](#) or [LC](#) entries in the [Service Catalog](#) (see [Signature](#) in [DV metadata](#)) *MUST* contain either a KeyInfo element with a X509Certificate element OR a KeyName element containing a key name. The use of KeyName is preferred as this limits the amount of data exchanged. The X509Certificate or KeyName *MUST* match a [X509Data](#) or [KeyName](#) in the [DV metadata KeyDescriptor](#) element with @use="signing".

Each Signature element in SAML messages generated by a [RD](#) (or any other [Participant](#)) and in the [Metadata](#) *MUST* contain a KeyInfo element with a KeyName element containing a key name that corresponds to a [KeyName](#) in a [KeyDescriptor](#) element in the [Metadata](#) for that [Participant](#).

Certificates used to verify a Signature *MUST* be retrieved from the [Participant's](#) verified [Metadata](#). The X509Certificate or KeyName in the KeyInfo of the Signature *MUST* only be used to retrieve the corresponding certificate from the [Participant's](#) verified [Metadata](#).

## §9.3 Encryption

Encryption is used to guarantee confidentiality. Encryption in combination with SAML is achieved via XML-encryption (see [EncryptedID](#)). In case encryption *MAY* or *MUST* be used, one *MUST* use the block encryption algorithms identified by the following URI in conjunction with the use of XML Encryption

algorithm	urn
-----------	-----

AES-256	<a href="http://www.w3.org/2001/04/xmenc#aes256-cbc">http://www.w3.org/2001/04/xmenc#aes256-cbc</a>
---------	---

For asymmetric encryption, used to encrypt keys, the RSA algorithm in combination with OAEP padding and a SHA digest *MUST* be used, as described at <http://www.w3.org/TR/xmlenc-core1/#sec-RSA-OAEP>. The SHA1 version *MUST* be used (<http://www.w3.org/2009/xmlenc11#mgf1sha1>).

## §9.4 TLS transport

[RD](#) requires that a service provider always protects http traffic with TLS v1.2 or higher in accordance with the NCSC directive with 'good' assessment (ICT security guidelines for Transport Layer Security (TLS)). The certificate used for this must be issued under PKIoverheid, and the certificate must have a key length of at least 2048 bits.

For the [Back Channel](#) between [RD](#) and the [DV](#) or [LC](#), both parties must use a PKIoverheid certificate and mutual authentication is mandatory. This is also called two-sided or mutual TLS.

## §9.5 NotBefore and NotOnOrAfter

[DVs](#) and [LCs](#) must respect the NotBefore and NotOnOrAfter parameters in the message elements and reject messages that do not comply and cancel the authentication. With a re-authentication, the entire protocol handling must take place.

For this it is advisable to use NTP servers (for example from the [nl.pool.ntp.org](http://nl.pool.ntp.org) collection of NTP servers). This measure is taken because lag can make the web service vulnerable to certain attacks on the authentication protocol.

## §9.6 Levels of assurance

The Levels of Assurance ([LoA](#)) that are supported in the interface are listed in [Level of Assurance](#).

## §9.7 Local session

The [DV](#) is responsible for keeping track of the local [EU](#) session. This session *MUST* be terminated after at most 15 minutes inactivity.

The [DV](#) must recognize replay attacks and ward off these attacks.

If the [DV](#) uses cookies to manage sessions, the "Secure" and "HttpOnly" parameters must be used.

### NOTE

The setting of the SameSite policy still has to be determined as browsers show inconsistent behavior.

## §9.8 RelayState

DVs may provide a RelayState for their own session monitoring. [RD](#) returns the RelayState value provided without any verification. The monitoring of the content and integrity of the RelayState must be done by the service provider ([DV](#)).

The SAML standard uses a maximum of 80 bytes for the RelayState (see the SAML standard).

## §9.9 EU interaction

When a [DV](#) forwards an [EU](#) to [RD](#) this must be done in such a way that it is clear to the [EU](#) on which website they are and that they can actually check this. That is why the following requirements apply:

1. The [EU](#) must be redirected to [RD](#) in the same screen that the [EU](#) clicked on "Log in to DigiD".
2. The [EU](#) must see a browser window with the full address bar. This allows an [EU](#) to see on which website he is entering his data. The [EU](#) can check this by inspecting the certificate (green lock).
3. It is not allowed to invoke [RD](#) in a frame or iframe, or to embed these websites in another way in a webpage of the [DV](#).

The [DV](#) must decide on the basis of the [Assertion in the AuthN-response](#) whether an [EU](#) can gain access to the [Service](#) or, in the case of re-authentication (applicable to SAML [SSO](#)), may continue his session.

If the status in the Assertion is not successful or the [EU](#) does not have the required [LoA](#) in the [AuthnContext](#) of the [Assertion in the AuthN-response](#) then:

1. The [DV](#) or [LC](#) *MUST* immediately end the current session of the [EU](#).
2. *SHOULD* show an appropriate message (see [SAML Error codes](#)).

## §10. Type definitions

This page and underlying pages describe identifier types which are used by [ST-SAML](#)

- [Attribute Identifier types](#)
- [Attribute representation Types](#)
- [EntityID Format](#)
- [Level of Assurance](#)

### §10.1 Attribute identifier types

[Stelsel Toegang SAML v1.0 specification](#) describes the following attribute identifier types

Attribute	urn	Remarks
BSN	urn:nl-eid-gdi:1.0:id:legacy-BSN	BSN. encoded in 9-digits, padded with leading 0 if needed. Example: 123456789 or 012345678.
BSN	urn:nl-eid-gdi:1.0:id:BSN	Encrypted Identity (see [ <a href="#">BSNk.DEC</a> ], Encrypted structures )
Pseudonym	urn:nl-eid-gdi:1.0:id:Pseudonym	Encrypted Pseudonym (see [ <a href="#">BSNk.DEC</a> ] Encrypted structures)

The following attributes may be supplied additionally, only through [ETD](#) (see <https://afsprakenstelsel.etoegang.nl/Startpagina/as/identificerende-kenmerken> )

### §10.2 Attribute representation types

The table shows the allowed representationTypes in URN format that are supported by the [BVD \(BVD-OG\)](#) and can be found in the [Attribute Statement](#) of the [AuthN Response - Assertion](#) as a unencrypted with @name Name="urn:nl-eid-gdi:1.1:RepresentationType". See [attribute for legal representation](#)

representation-types	urn	Sector	description
Zorg_Volledig_Gezag_Kind	urn:nl-eid-gdi:1.1:RT:Zorg_Volledig_Gezag_Kind	health care	Specific Parental authority for children under 12 years old in healthcare

### §10.3 EntityID Format

The format of value of the @entityID attribute is: urn:nl-eid-gdi:1.0:<ROLE>:<QIN>:entities:<index>

#### <OIN>

The OIN of the organization.

#### <ROLE>

Indication of the role of the entity:

- AD
- DV
- BVD
- LC
- RD

#### <index>

The <index> is a number with 4 positions between 0000 and 8999 that can be selected by the [Participant](#) to define different endpoints (in the [Metadata](#)). Numbers between 9000 and 9999 are reserved for test systems.

### §10.4 Level of Assurance

The table shows the four Levels of Assurance supported by [ST-SAML](#) and the corresponding urn's which are used in the SAML messages.

LoA	urn
Basis	<a href="http://eID.logius.nl/LoA/basic">http://eID.logius.nl/LoA/basic</a>
Midden	<a href="http://eidas.europa.eu/LoA/low">http://eidas.europa.eu/LoA/low</a>
Substantieel	<a href="http://eidas.europa.eu/LoA/substantial">http://eidas.europa.eu/LoA/substantial</a>
Hoog	<a href="http://eidas.europa.eu/LoA/high">http://eidas.europa.eu/LoA/high</a>

### §A. Example SAML messages

*This section is non-normative.*

## §A.1 Example - AuthnRequest

### EXAMPLE 1: AuthnRequest

```
<?xml version="1.0" encoding="UTF-8"?>
<samlp:AuthnRequest AssertionConsumerServiceIndex="0" AttributeConsumingServiceIndex="1"
  Destination="http://idp.example.com/request_authentication"
  ID="_56ae2ef7ff51845153d8960e5b73d45128ad6d62" IssueInstant="2021-02-
  xmlns:ds="http://www.w3.org/2000/09/xmldsig#" xmlns:ec="http://www.w3
  xmlns:saml="urn:oasis:names:tc:SAML:2.0:assertion"
  xmlns:samlp="urn:oasis:names:tc:SAML:2.0:protocol">
  <saml:Issuer>urn:nl-eid-gdi:1.0:DV:0000000999999999001:entities:0000</saml:Issuer>
  <ds:Signature>
    <ds:SignedInfo>
      <ds:CanonicalizationMethod Algorithm="http://www.w3.org/2001/10/xml-exc-c14n#
      <ds:SignatureMethod Algorithm="http://www.w3.org/2001/04/xmldsig-more#rsa-sha
      <ds:Reference URI="#_56ae2ef7ff51845153d8960e5b73d45128ad6d62">
        <ds:Transforms>
          <ds:Transform Algorithm="http://www.w3.org/2000/09/xmldsig#enveloped-
          <ds:Transform Algorithm="http://www.w3.org/2001/10/xml-exc-c14n#">
            <ec:InclusiveNamespaces PrefixList="ds saml samlp xs"/>
          </ds:Transform>
        </ds:Transforms>
        <ds:DigestMethod Algorithm="http://www.w3.org/2001/04/xmenc#sha256"/>
        <ds:DigestValue>...</ds:DigestValue>
      </ds:Reference>
    </ds:SignedInfo>
    <ds:SignatureValue>...</ds:SignatureValue>
    <ds:KeyInfo>
      <ds:KeyName>4492219ba557ce9e547a933d15ab87b14a69788d</ds:KeyName>
    </ds:KeyInfo>
  </ds:Signature>
</samlp:AuthnRequest>
```

## §A.2 Example - AuthnRequest using Extensions

### EXAMPLE 2: AuthnRequest using Extensions

```
<?xml version="1.0" encoding="UTF-8"?>
<saml:AuthnRequest xmlns:ds="http://www.w3.org/2000/09/xmldsig#"
  xmlns:saml="urn:oasis:names:tc:SAML:2.0:assertion"
  xmlns:samlp="urn:oasis:names:tc:SAML:2.0:protocol"
  Destination="http://idp.example.com/request_authentication"
  ForceAuthn="false" ID="_d68fdd07cb64ca845317aa145969187c1514129b"
  IsPassive="false" IssueInstant="2021-04-15T14:20:38Z" Version="2.0">
  <saml:Issuer Format="urn:oasis:names:tc:SAML:2.0:nameid-format:entity">
    urn:nl-eid-gdi:1.0:DV:00000009999999999001:entities:0000
  </saml:Issuer>
  <ds:Signature Id="uuid5e7c2bf-0178-146b-8597-ef90aa0f4487">
    <ds:SignedInfo>
      <ds:CanonicalizationMethod Algorithm="http://www.w3.org/2001/10/xml-exc-c14n#"
      <ds:SignatureMethod Algorithm="http://www.w3.org/2001/04/xmldsig-more#rsa-sha
      <ds:Reference URI="#_d68fdd07cb64ca845317aa145969187c1514129b">
        <ds:Transforms>
          <ds:Transform Algorithm="http://www.w3.org/2000/09/xmldsig#enveloped-
          <ds:Transform Algorithm="http://www.w3.org/2001/10/xml-exc-c14n#">
            <xc14n:InclusiveNamespaces xmlns:xc14n="http://www.w3.org/2001/10
              PrefixList="samlp saml ds"></xc14n:Inc
          </ds:Transform>
        </ds:Transforms>
        <ds:DigestMethod Algorithm="http://www.w3.org/2001/04/xmldsig#sha256"></ds
        <ds:DigestValue>...</ds:DigestValue>
      </ds:Reference>
    </ds:SignedInfo>
    <ds:SignatureValue>...</ds:SignatureValue>
  </ds:Signature>
  <samlp:Extensions>
    <saml:Attribute Name="urn:nl-eid-gdi:1.0:ServiceUUID">
      <saml:AttributeValue>336fa5edb569-13fb-b3e4-8968-86c62aea</saml:AttributeValu
    </saml:Attribute>
    <saml:Attribute Name="urn:nl-eid-gdi:1.0:IntendedAudience">
      <saml:AttributeValue>urn:nl-eid-gdi:1.0:DV:00000009999999999001:entities:0000
    </saml:Attribute>
  </samlp:Extensions>
</saml:AuthnRequest>
```

## §A.3 Example - AuthnRequest with Representation

### EXAMPLE 3: AuthnRequest with Representation

```
<?xml version="1.0" encoding="UTF-8"?>
<samlp:AuthnRequest AssertionConsumerServiceIndex="0" AttributeConsumingServiceIndex="1"
  Destination="http://idp.example.com/request_authentication"
  ID="_56ae2ef7ff51845153d8960e5b73d45128ad6d62" IssueInstant="2021-02-
  xmlns:ds="http://www.w3.org/2000/09/xmldsig#" xmlns:ec="http://www.w3
  xmlns:saml="urn:oasis:names:tc:SAML:2.0:assertion"
  xmlns:samlp="urn:oasis:names:tc:SAML:2.0:protocol">
  <saml:Issuer>urn:nl-eid-gdi:1.0:DV:0000000999999999001:entities:0000</saml:Issuer>
  <ds:Signature>
    <ds:SignedInfo>
      <ds:CanonicalizationMethod Algorithm="http://www.w3.org/2001/10/xml-exc-c14n#
      <ds:SignatureMethod Algorithm="http://www.w3.org/2001/04/xmldsig-more#rsa-sha
      <ds:Reference URI="#_56ae2ef7ff51845153d8960e5b73d45128ad6d62">
        <ds:Transforms>
          <ds:Transform Algorithm="http://www.w3.org/2000/09/xmldsig#enveloped-
          <ds:Transform Algorithm="http://www.w3.org/2001/10/xml-exc-c14n#">
            <ec:InclusiveNamespaces PrefixList="ds saml samlp xs"/>
          </ds:Transform>
        </ds:Transforms>
        <ds:DigestMethod Algorithm="http://www.w3.org/2001/04/xmenc#sha256"/>
        <ds:DigestValue>...</ds:DigestValue>
      </ds:Reference>
    </ds:SignedInfo>
    <ds:SignatureValue>...</ds:SignatureValue>
    <ds:KeyInfo>
      <ds:KeyName>4492219ba557ce9e547a933d15ab87b14a69788d</ds:KeyName>
    </ds:KeyInfo>
  </ds:Signature>
  <samlp:Scoping>
    <samlp:RequesterID>urn:nl-eid-gdi:1.0:BVD:00000004003214345001:entities:9000</sar
  </samlp:Scoping>
</samlp:AuthnRequest>
```

## §A.4 Example - ArtifactResponse with Legal Representation

### EXAMPLE 4: ArtifactResponse with Legal Representation

```
<?xml version="1.0" encoding="UTF-8"?>
<soap11:Envelope xmlns:soap11="http://schemas.xmlsoap.org/soap/envelope/">
  <soap11:Body>
    <saml2p:ArtifactResponse xmlns:saml2p="urn:oasis:names:tc:SAML:2.0:protocol"
      ID="_0fb52522f6e41b750df938ef5ea50154"
      InResponseTo="_1ea090efda5655760b6a0c9dfa8884b66d475222"
      IssueInstant="2025-05-05T08:10:51.018Z" Version="2.0">
      <saml2:Issuer xmlns:saml2="urn:oasis:names:tc:SAML:2.0:assertion">
        urn:nl-eid-gdi:1.0:TD:00000004183317817000:entities:9000
      </saml2:Issuer>
      <ds:Signature xmlns:ds="http://www.w3.org/2000/09/xmldsig#">
        <ds:SignedInfo>
          <ds:CanonicalizationMethod Algorithm="http://www.w3.org/2001/10/xml-e
          <ds:SignatureMethod Algorithm="http://www.w3.org/2001/04/xmldsig-more
          <ds:Reference URI="#_0fb52522f6e41b750df938ef5ea50154">
            <ds:Transforms>
              <ds:Transform Algorithm="http://www.w3.org/2000/09/xmldsig#en
              <ds:Transform Algorithm="http://www.w3.org/2001/10/xml-exc-c1
            </ds:Transforms>
            <ds:DigestMethod Algorithm="http://www.w3.org/2001/04/xmlenc#sha2
            <ds:DigestValue>...</ds:DigestValue>
          </ds:Reference>
        </ds:SignedInfo>
        <ds:SignatureValue>...</ds:SignatureValue>
        <ds:KeyInfo>
          <ds:KeyName>356b4241808341cc9ff6295a43b01d00daab27406ddcd3f708a0a3761
        </ds:KeyInfo>
      </ds:Signature>
    </saml2p:ArtifactResponse>
    <saml2p:Status>
      <saml2p:StatusCode Value="urn:oasis:names:tc:SAML:2.0:status:Success"/>
    </saml2p:Status>
    <saml2p:Response>
      Destination="sp.example.com"
      ID="_31fa010c6af1bc61583f22c84b3a2b0d" InResponseTo="_a658d2c5c7426b1
      IssueInstant="2021-10-06T08:10:51.018Z" Version="2.0">
      <saml2:Issuer xmlns:saml2="urn:oasis:names:tc:SAML:2.0:assertion">
        urn:nl-eid-gdi:1.0:TD:00000004183317817000:entities:9000
      </saml2:Issuer>
      <saml2p:Status>
        <saml2p:StatusCode Value="urn:oasis:names:tc:SAML:2.0:status:Success"
      </saml2p:Status>
      <saml2:Assertion xmlns:saml2="urn:oasis:names:tc:SAML:2.0:assertion"
        ID="_2a9deaff3a95b2193e74dbad4a69dfbf" IssueInstant="202
        Version="2.0">
      <saml2:Issuer>urn:nl-eid-gdi:1.0:TD:00000004183317817000:entities:900
      <ds:Signature xmlns:ds="http://www.w3.org/2000/09/xmldsig#">
        <ds:SignedInfo>
          <ds:CanonicalizationMethod Algorithm="http://www.w3.org/2001/
          <ds:SignatureMethod Algorithm="http://www.w3.org/2001/04/xmld
          <ds:Reference URI="#_2a9deaff3a95b2193e74dbad4a69dfbf">
            <ds:Transforms>
              <ds:Transform Algorithm="http://www.w3.org/2000/09/xr
              <ds:Transform Algorithm="http://www.w3.org/2001/10/xr
            </ds:Transforms>
            <ds:DigestMethod Algorithm="http://www.w3.org/2001/04/xml
            <ds:DigestValue>...</ds:DigestValue>
          </ds:Reference>
        </ds:SignedInfo>
        <ds:SignatureValue>...</ds:SignatureValue>
        <ds:KeyInfo>
```

```
<ds:KeyName>356b4241808341cc9ff6295a43b01d00daab27406ddcd3f76
</ds:KeyInfo>
</ds:Signature>
<saml2:Subject>
  <saml2:NameID Format="urn:oasis:names:tc:SAML:2.0:nameid-format:t
    45e376c5-78a7-4cdc-a27d-a7dd5056e786
  </saml2:NameID>
  <saml2:SubjectConfirmation Method="urn:oasis:names:tc:SAML:2.0:cr
    <saml2:SubjectConfirmationData InResponseTo="_a658d2c5c7426b1
      NotOnOrAfter="2021-10-06T08:12
      Recipient="http://sp.example.c
    </saml2:SubjectConfirmation>
  </saml2:Subject>
<saml2:Conditions NotBefore="2021-10-06T08:08:50.916Z" NotOnOrAfter="
  <saml2:AudienceRestriction>
    <saml2:Audience>urn:nl-eid-gdi:1.0:DV:000000999999999004:en
  </saml2:AudienceRestriction>
</saml2:Conditions>
<saml2:Advice>
  <saml2:Assertion ID="_797775d153ac85fe682d1c89f668adc1" IssueInst
    Version="2.0" xmlns:saml2="urn:oasis:names:tc:SA
  <saml2:Issuer>urn:nl-eid-gdi:1.0:AD:0000000273813120000:entit
  <ds:Signature xmlns:ds="http://www.w3.org/2000/09/xmlsig#">
    <ds:SignedInfo>
      <ds:CanonicalizationMethod Algorithm="http://www.w3.c
      <ds:SignatureMethod Algorithm="http://www.w3.org/2001
      <ds:Reference URI="#_797775d153ac85fe682d1c89f668adc1
        <ds:Transforms>
          <ds:Transform
            Algorithm="http://www.w3.org/2000/09/
          <ds:Transform Algorithm="http://www.w3.org/20
        </ds:Transforms>
      <ds:DigestMethod Algorithm="http://www.w3.org/200
      <ds:DigestValue>...</ds:DigestValue>
    </ds:Reference>
  </ds:SignedInfo>
  <ds:SignatureValue>...</ds:SignatureValue>
  <ds:KeyInfo>
    <ds:KeyName>24b1a2189f8af57114df0b93120f88b1d9cd38a0f
    </ds:KeyName>
  </ds:KeyInfo>
</ds:Signature>
<saml2:Subject>
  <saml2:NameID Format="urn:oasis:names:tc:SAML:2.0:nameid-
    45e376c5-78a7-4cdc-a27d-a7dd5056e786
  </saml2:NameID>
  <saml2:SubjectConfirmation Method="urn:oasis:names:tc:SAV
    <saml2:SubjectConfirmationData
      InResponseTo="_a658d2c5c7426b11dfbdbl30d4b0c
      NotOnOrAfter="2021-10-06T08:12:50.916Z"
      Recipient="http://sp.example.com"/>
    </saml2:SubjectConfirmation>
  </saml2:Subject>
<saml2:Conditions NotBefore="2021-10-06T08:08:50.916Z"
  NotOnOrAfter="2021-10-06T08:12:50.916Z">
  <saml2:AudienceRestriction>
    <saml2:Audience>urn:nl-eid-gdi:1.0:DV:000000999999999
  </saml2:Audience>
  </saml2:AudienceRestriction>
</saml2:Conditions>
<saml2:AuthnStatement AuthnInstant="2021-10-06T08:10:51.029Z"
  <saml2:AuthnContext>
    <saml2:AuthnContextClassRef>http://eid.logius.nl/LoA/
  </saml2:AuthnContextClassRef>
  </saml2:AuthnContext>
</saml2:AuthnStatement>
<saml2:AttributeStatement>
```

```

<saml2:Attribute Name="urn:nl-eid-gdi:1.0:ServiceUUID">
  <saml2:AttributeValue>375b1cb114b7-12e9-3534-16cc-4d8
</saml2:Attribute>
<saml2:Attribute Name="urn:nl-eid-gdi:1.0:ActingSubjectID"
  <saml2:AttributeValue>
    <saml2:EncryptedID>
      <xenc:EncryptedData xmlns:xenc="http://www.w3
        Id="_e4ed5fc71f364184a43a
        Type="http://www.w3.org/2
      <xenc:EncryptionMethod
        Algorithm="http://www.w3.org/2001
        xmlns:xenc="http://www.w3.org/200
      <ds:KeyInfo xmlns:ds="http://www.w3.org/2
        <ds:RetrievalMethod
          Type="http://www.w3.org/2001/
          URI="#_0cee1f147ad7e995e77e67
        </ds:KeyInfo>
      <xenc:CipherData xmlns:xenc="http://www.w
        <xenc:CipherValue>...</xenc:CipherVal
      </xenc:CipherData>
    </xenc:EncryptedData>
    <xenc:EncryptedKey xmlns:xenc="http://www.w3.
      Id="_0cee1f147ad7e995e77e6
      Recipient="urn:nl-eid-gdi:
    <xenc:EncryptionMethod
      Algorithm="http://www.w3.org/2001
      xmlns:xenc="http://www.w3.org/200
    <ds:DigestMethod xmlns:ds="http://www
      Algorithm="http://ww
    </xenc:EncryptionMethod>
    <ds:KeyInfo xmlns:ds="http://www.w3.org/2
      <ds:KeyName>1d0bc832d839df789eca8bae6
    </ds:KeyInfo>
    <xenc:CipherData xmlns:xenc="http://www.w
      <xenc:CipherValue>...</xenc:CipherVal
    </xenc:CipherData>
    <xenc:ReferenceList>
      <xenc:DataReference URI="#_e4ed5fc71f
    </xenc:ReferenceList>
  </xenc:EncryptedKey>
  <xenc:EncryptedKey xmlns:xenc="http://
    Id="_0cee1f147ad7e995e77e6
    Recipient="urn:nl-eid-gdi:
  <xenc:EncryptionMethod
    Algorithm="http://www.w3.org/2001
    xmlns:xenc="http://www.w3.org/200
  <ds:DigestMethod xmlns:ds="http://www
    Algorithm="http://ww
  </xenc:EncryptionMethod>
  <ds:KeyInfo xmlns:ds="http://www.w3.org/2
    <ds:KeyName>2c0bc832d839df789eca8bae6
  </ds:KeyInfo>
  <xenc:CipherData xmlns:xenc="http://www.w
    <xenc:CipherValue>...</xenc:CipherVal
  </xenc:CipherData>
  <xenc:ReferenceList>
    <xenc:DataReference URI="#_e4ed5fc71f
  </xenc:ReferenceList>
  </xenc:EncryptedKey>
</saml2:EncryptedID>
</saml2:AttributeValue>
</saml2:Attribute>
</saml2:AttributeStatement>
</saml2:Assertion>
<saml2:Assertion ID="_c7a79a0e92311f0d3d2dad247a855f6" IssueInst
  Version="2.0" xmlns:saml2="urn:oasis:names:tc:SA
  <saml2:Issuer>urn:nl-eid-gdi:1.0:BVD:00000004003214345001:ent

```

```

<ds:Signature xmlns:ds="http://www.w3.org/2000/09/xmldsig#">
  <ds:SignedInfo>
    <ds:CanonicalizationMethod Algorithm="http://www.w3.org/2001/04/xmlenc#canonical"></ds:CanonicalizationMethod>
    <ds:SignatureMethod Algorithm="http://www.w3.org/2001/04/xmlenc#sha256"></ds:SignatureMethod>
    <ds:Reference URI="#_c7a79a0e92311f0d3d2dad247a855f6">
      <ds:Transforms>
        <ds:Transform Algorithm="http://www.w3.org/2000/09/xmldsig#enveloping-signature"></ds:Transform>
        <ds:Transform Algorithm="http://www.w3.org/2001/04/xmlenc#sha256"></ds:Transform>
      </ds:Transforms>
      <ds:DigestMethod Algorithm="http://www.w3.org/2001/04/xmlenc#sha256"></ds:DigestMethod>
      <ds:DigestValue>...</ds:DigestValue>
    </ds:Reference>
  </ds:SignedInfo>
  <ds:SignatureValue>...</ds:SignatureValue>
  <ds:KeyInfo>
    <ds:KeyName>4202df88ba9faae2d2860a0d821d2bde10babc0a2</ds:KeyName>
  </ds:KeyInfo>
</ds:Signature>
<saml2:Subject>
  <saml2:NameID Format="urn:oasis:names:tc:SAML:2.0:nameid-format:emailAddress">45e376c5-78a7-4cdc-a27d-a7dd5056e786</saml2:NameID>
  <saml2:SubjectConfirmation Method="urn:oasis:names:tc:SAML:2.0:subjectconfirmation:recipient-url">
    <saml2:SubjectConfirmationData InResponseTo="_a658d2c5c7426b11dfbdb1e30d4b0c" NotOnOrAfter="2021-10-06T08:12:50.916Z" Recipient="http://sp.example.com"/>
  </saml2:SubjectConfirmation>
</saml2:Subject>
<saml2:Conditions NotBefore="2021-10-06T08:08:50.916Z" NotOnOrAfter="2021-10-06T08:12:50.916Z">
  <saml2:AudienceRestriction>
    <saml2:Audience>urn:nl-eid-gdi:1.0:DV:00000099999999</saml2:Audience>
  </saml2:AudienceRestriction>
</saml2:Conditions>
<saml2:AuthnStatement AuthnInstant="2021-10-06T08:10:51.090Z">
  <saml2:AuthnContext>
    <saml2:AuthnContextClassRef>http://eid.logius.nl/LoA/</saml2:AuthnContextClassRef>
  </saml2:AuthnContext>
</saml2:AuthnStatement>
<saml2:AttributeStatement>
  <saml2:Attribute Name="urn:nl-eid-gdi:1.0:ServiceUUID">
    <saml2:AttributeValue>375b1cb114b7-12e9-3534-16cc-4d8</saml2:AttributeValue>
  </saml2:Attribute>
  <saml2:Attribute Name="urn:nl-eid-gdi:1.1:Representat">
    <saml2:AttributeValue>urn:nl-eid-gdi:1.1:RT:Zorg_Vo</saml2:AttributeValue>
  </saml2:Attribute>
  <saml2:Attribute Name="urn:nl-eid-gdi:1.0:ActingSubjectID">
    <saml2:AttributeValue>
      <saml2:EncryptedID>
        <xenc:EncryptedData xmlns:xenc="http://www.w3.org/2001/04/xmlenc#" Id="_d4eb5b0632d388373948" Type="http://www.w3.org/2001/04/xmlenc#aes256-gcm">
          <xenc:EncryptionMethod Algorithm="http://www.w3.org/2001/04/xmlenc#aes256-gcm" xmlns:xenc="http://www.w3.org/2001/04/xmlenc#"></xenc:EncryptionMethod>
          <ds:KeyInfo xmlns:ds="http://www.w3.org/2000/09/xmldsig#">
            <ds:RetrievalMethod Type="http://www.w3.org/2001/04/xmlenc#uri" URI="#_720276d2e729cdec6889f"></ds:RetrievalMethod>
          </ds:KeyInfo>
          <xenc:CipherData xmlns:xenc="http://www.w3.org/2001/04/xmlenc#">
            <xenc:CipherValue>...</xenc:CipherValue>
          </xenc:CipherData>
        </xenc:EncryptedData>
      </saml2:EncryptedID>
    </saml2:AttributeValue>
  </saml2:Attribute>
</saml2:AttributeStatement>
</saml2:AttributeStatement>

```

```

        </xenc:CipherData>
    </xenc:EncryptedData>
    <xenc:EncryptedKey xmlns:xenc="http://www.w3.
        Id="_720276d2e729cdec6889
        Recipient="urn:nl-eid-gdi:
        <xenc:EncryptionMethod
            Algorithm="http://www.w3.org/2001
            xmlns:xenc="http://www.w3.org/200
            <ds:DigestMethod xmlns:ds="http://www
                Algorithm="http://ww
        </xenc:EncryptionMethod>
        <ds:KeyInfo xmlns:ds="http://www.w3.org/2
            <ds:KeyName>1d0bc832d839df789eca8bae6
        </ds:KeyInfo>
        <xenc:CipherData xmlns:xenc="http://www.w
            <xenc:CipherValue>...</xenc:CipherVal
        </xenc:CipherData>
        <xenc:ReferenceList>
            <xenc:DataReference URI="#_d4eb5b0632
        </xenc:ReferenceList>
    </xenc:EncryptedKey>
</samL2:EncryptedID>
</samL2:AttributeValue>
</samL2:Attribute>
<samL2:Attribute Name="urn:nl-eid-gdi:1.0:LegalSubjectID"
    <samL2:AttributeValue>
        <samL2:EncryptedID>
            <xenc:EncryptedData xmlns:xenc="http://www.w3
                Id="_0fbab7451567b5041390
                Type="http://www.w3.org/2
            <xenc:EncryptionMethod
                Algorithm="http://www.w3.org/2001
                xmlns:xenc="http://www.w3.org/200
            <ds:KeyInfo xmlns:ds="http://www.w3.org/2
                <ds:RetrievalMethod
                    Type="http://www.w3.org/2001/
                    URI="#_2cab7ef2667689c6064dda
            </ds:KeyInfo>
            <xenc:CipherData xmlns:xenc="http://www.w
                <xenc:CipherValue>...</xenc:CipherVal
            </xenc:CipherData>
        </xenc:EncryptedData>
        <xenc:EncryptedKey xmlns:xenc="http://www.w3.
            Id="_2cab7ef2667689c6064dd
            Recipient="urn:nl-eid-gdi:
            <xenc:EncryptionMethod
                Algorithm="http://www.w3.org/2001
                xmlns:xenc="http://www.w3.org/200
                <ds:DigestMethod xmlns:ds="http://www
                    Algorithm="http://ww
            </xenc:EncryptionMethod>
            <ds:KeyInfo xmlns:ds="http://www.w3.org/2
                <ds:KeyName>1d0bc832d839df789eca8bae6
            </ds:KeyInfo>
            <xenc:CipherData xmlns:xenc="http://www.w
                <xenc:CipherValue>...</xenc:CipherVal
            </xenc:CipherData>
            <xenc:ReferenceList>
                <xenc:DataReference URI="#_0fbab74515
            </xenc:ReferenceList>
        </xenc:EncryptedKey>
    </samL2:EncryptedID>
</samL2:AttributeValue>
</samL2:Attribute>
</samL2:AttributeStatement>
</samL2:Assertion>
</samL2:Advice>

```

```

<saml2:AuthnStatement AuthnInstant="2021-10-06T08:10:51.018Z" Session
  <saml2:AuthnContext>
    <saml2:AuthnContextClassRef>http://eid.logius.nl/LoA/basic</s
    <saml2:AuthenticatingAuthority>urn:nl-eid-gdi:1.0:AD:00000002
    </saml2:AuthenticatingAuthority>
    <saml2:AuthenticatingAuthority>urn:nl-eid-gdi:1.0:BVD:00000006
    </saml2:AuthenticatingAuthority>
  </saml2:AuthnContext>
</saml2:AuthnStatement>
<saml2:AttributeStatement>
  <saml2:Attribute Name="urn:nl-eid-gdi:1.0:ServiceUUID">
    <saml2:AttributeValue>375b1cb114b7-12e9-3534-16cc-4d8997b0</s
  </saml2:Attribute>
<saml2:Attribute Name="urn:nl-eid-gdi:1.1:RepresentationType">
<saml2:AttributeValue>urn:nl-eid-gdi:1.1:RT:Zorg_Volledig_Gezag_Kind</sar
</saml2:Attribute>
  <saml2:Attribute Name="urn:nl-eid-gdi:1.0:ActingSubjectID">
    <saml2:AttributeValue>
      <saml2:EncryptedID>
        <xenc:EncryptedData xmlns:xenc="http://www.w3.org/200
          Id="_c108a849ffb239e73ac6083348ad
          Type="http://www.w3.org/2001/04/x
        <xenc:EncryptionMethod Algorithm="http://www.w3.o
          xmlns:xenc="http://www.w3.
        <ds:KeyInfo xmlns:ds="http://www.w3.org/2000/09/x
          <ds:RetrievalMethod Type="http://www.w3.org/2
            URI="#_df56cc944ecbb3a06f
          </ds:KeyInfo>
        <xenc:CipherData xmlns:xenc="http://www.w3.org/20
          <xenc:CipherValue>...</xenc:CipherValue>
        </xenc:CipherData>
      </xenc:EncryptedData>
      <xenc:EncryptedKey xmlns:xenc="http://www.w3.org/2001
        Id="_df56cc944ecbb3a06fe5d0a0d45aa
        Recipient="urn:nl-eid-gdi:1.0:DV:0
      <xenc:EncryptionMethod
        Algorithm="http://www.w3.org/2001/04/xmle
        xmlns:xenc="http://www.w3.org/2001/04/xml
      <ds:DigestMethod xmlns:ds="http://www.w3.org/
        Algorithm="http://www.w3.org
      </xenc:EncryptionMethod>
      <ds:KeyInfo xmlns:ds="http://www.w3.org/2000/09/x
        <ds:KeyName>1d0bc832d839df789eca8bae611c3ad7e
      </ds:KeyInfo>
      <xenc:CipherData xmlns:xenc="http://www.w3.org/20
        <xenc:CipherValue>...</xenc:CipherValue>
      </xenc:CipherData>
      <xenc:ReferenceList>
        <xenc:DataReference URI="#_c108a849ffb239e73a
      </xenc:ReferenceList>
    </xenc:EncryptedKey>
  </saml2:EncryptedID>
</saml2:AttributeValue>
</saml2:Attribute>
<saml2:Attribute Name="urn:nl-eid-gdi:1.0:LegalSubjectID">
  <saml2:AttributeValue>
    <saml2:EncryptedID>
      <xenc:EncryptedData xmlns:xenc="http://www.w3.org/200
        Id="_5d50f7898d8afda532502d7f82e4
        Type="http://www.w3.org/2001/04/x
      <xenc:EncryptionMethod Algorithm="http://www.w3.c
        xmlns:xenc="http://www.w3.
      <ds:KeyInfo xmlns:ds="http://www.w3.org/2000/09/x
        <ds:RetrievalMethod Type="http://www.w3.org/2
          URI="#_ea31225223bb330ed5
        </ds:KeyInfo>
      <xenc:CipherData xmlns:xenc="http://www.w3.org/20

```

```
        <xenc:CipherValue>...</xenc:CipherValue>
      </xenc:CipherData>
    </xenc:EncryptedData>
  <xenc:EncryptedKey xmlns:xenc="http://www.w3.org/2001
    Id="_ea31225223bb330ed5fe42bb55f01
    Recipient="urn:nl-eid-gdi:1.0:DV:0
  <xenc:EncryptionMethod
    Algorithm="http://www.w3.org/2001/04/xmle
    xmlns:xenc="http://www.w3.org/2001/04/xml
  <ds:DigestMethod xmlns:ds="http://www.w3.org/
    Algorithm="http://www.w3.org
  </xenc:EncryptionMethod>
  <ds:KeyInfo xmlns:ds="http://www.w3.org/2000/09/x
    <ds:KeyName>1d0bc832d839df789eca8bae611c3ad7e
  </ds:KeyInfo>
  <xenc:CipherData xmlns:xenc="http://www.w3.org/20
    <xenc:CipherValue>...</xenc:CipherValue>
  </xenc:CipherData>
  <xenc:ReferenceList>
    <xenc:DataReference URI="#_5d50f7898d8afda532
  </xenc:ReferenceList>
  </xenc:EncryptedKey>
  </saml2:EncryptedID>
  </saml2:AttributeValue>
  </saml2:Attribute>
  </saml2:AttributeStatement>
  </saml2:Assertion>
  </saml2p:Response>
  </saml2p:ArtifactResponse>
</soap11:Body>
</soap11:Envelope>
```

## §A.5 Example - ArtifactResolve

### EXAMPLE 5: ArtifactResolve

```
<?xml version="1.0" encoding="UTF-8"?>
<soapenv:Envelope xmlns:soapenv="http://schemas.xmlsoap.org/soap/envelope/">
  <soapenv:Body>
    <samlp:ArtifactResolve xmlns:samlp="urn:oasis:names:tc:SAML:2.0:protocol"
      xmlns:saml="urn:oasis:names:tc:SAML:2.0:assertion"
      xmlns:ds="http://www.w3.org/2000/09/xmldsig#"
      xmlns:ec="http://www.w3.org/2001/10/xml-exc-c14n#"
      ID="_f0c06d3728f5da98c417b5add105d3c07cc3c868" Version="2.
      IssueInstant="2021-06-03T10:38:38Z"
      Destination="http://idp.example.com/resolve_artifact">
      <saml:Issuer>urn:n1-eid-gdi:1.0:DV:000000099999999999001:entities:0000</saml:I
      <ds:Signature>
        <ds:SignedInfo>
          <ds:CanonicalizationMethod Algorithm="http://www.w3.org/2001/10/xml-e
          <ds:SignatureMethod Algorithm="http://www.w3.org/2001/04/xmldsig-more
          <ds:Reference URI="#_f0c06d3728f5da98c417b5add105d3c07cc3c868">
            <ds:Transforms>
              <ds:Transform Algorithm="http://www.w3.org/2000/09/xmldsig#en
              <ds:Transform Algorithm="http://www.w3.org/2001/10/xml-exc-c1
                <ec:InclusiveNamespaces PrefixList="ds saml samlp xs"/>
              </ds:Transform>
            </ds:Transforms>
            <ds:DigestMethod Algorithm="http://www.w3.org/2001/04/xmlenc#sha2
            <ds:DigestValue>...</ds:DigestValue>
          </ds:Reference>
        </ds:SignedInfo>
        <ds:SignatureValue>...</ds:SignatureValue>
        <ds:KeyInfo>
          <ds:KeyName>4492219ba557ce9e547a933d15ab87b14a69788d</ds:KeyName>
        </ds:KeyInfo>
      </ds:Signature>
      <samlp:Artifact>AAQAAHZHHN7zNFV4yhPfX5thN0sFe10xr4B3crRVEmPn4m3DE2V GisdfYs</
    </samlp:ArtifactResolve>
  </soapenv:Body>
</soapenv:Envelope>
```

## §A.6 Example - ArtifactResponse

### EXAMPLE 6: ArtifactResponse

```
<?xml version="1.0" encoding="UTF-8"?>
<soap11:Envelope xmlns:soap11="http://schemas.xmlsoap.org/soap/envelope/">
  <soap11:Body>
    <saml2p:ArtifactResponse xmlns:saml2p="urn:oasis:names:tc:SAML:2.0:protocol"
      ID="_4d4d3e6984b2b2c036d7ee55d424ac78"
      InResponseTo="_8ecc43a04fc541f850fb66eb7259232b2d55627a"
      IssueInstant="2021-10-06T08:09:50.226Z" Version="2.0">
      <saml2:Issuer xmlns:saml2="urn:oasis:names:tc:SAML:2.0:assertion">
        urn:nl-eid-gdi:1.0:TD:00000004183317817000:entities:9000
      </saml2:Issuer>
      <ds:Signature xmlns:ds="http://www.w3.org/2000/09/xmldsig#">
        <ds:SignedInfo>
          <ds:CanonicalizationMethod Algorithm="http://www.w3.org/2001/10/xml-e
          <ds:SignatureMethod Algorithm="http://www.w3.org/2001/04/xmldsig-more
          <ds:Reference URI="#_4d4d3e6984b2b2c036d7ee55d424ac78">
            <ds:Transforms>
              <ds:Transform Algorithm="http://www.w3.org/2000/09/xmldsig#en
              <ds:Transform Algorithm="http://www.w3.org/2001/10/xml-exc-c1
            </ds:Transforms>
            <ds:DigestMethod Algorithm="http://www.w3.org/2001/04/xmlenc#sha2
            <ds:DigestValue>...</ds:DigestValue>
          </ds:Reference>
        </ds:SignedInfo>
        <ds:SignatureValue>...</ds:SignatureValue>
        <ds:KeyInfo>
          <ds:KeyName>356b4241808341cc9ff6295a43b01d00daab27406ddcd3f708a0a3761
        </ds:KeyInfo>
      </ds:Signature>
    <saml2p:Status>
      <saml2p:StatusCode Value="urn:oasis:names:tc:SAML:2.0:status:Success"/>
    </saml2p:Status>
    <saml2p:Response>
      Destination="http://sp.example.com"
      ID="_99e95c51026d2af9914a2269a39519c5" InResponseTo="_e1234e91b147553
      IssueInstant="2021-10-06T08:09:50.229Z" Version="2.0">
      <saml2:Issuer xmlns:saml2="urn:oasis:names:tc:SAML:2.0:assertion">
        urn:nl-eid-gdi:1.0:TD:00000004183317817000:entities:9000
      </saml2:Issuer>
      <saml2p:Status>
        <saml2p:StatusCode Value="urn:oasis:names:tc:SAML:2.0:status:Success"
      </saml2p:Status>
      <saml2:Assertion xmlns:saml2="urn:oasis:names:tc:SAML:2.0:assertion"
        ID="_12bb5ba7a77b6e09983fa26af000cfac" IssueInstant="202
        Version="2.0">
      <saml2:Issuer>urn:nl-eid-gdi:1.0:TD:00000004183317817000:entities:900
      <ds:Signature xmlns:ds="http://www.w3.org/2000/09/xmldsig#">
        <ds:SignedInfo>
          <ds:CanonicalizationMethod Algorithm="http://www.w3.org/2001/
          <ds:SignatureMethod Algorithm="http://www.w3.org/2001/04/xmld
          <ds:Reference URI="#_12bb5ba7a77b6e09983fa26af000cfac">
            <ds:Transforms>
              <ds:Transform Algorithm="http://www.w3.org/2000/09/xr
              <ds:Transform Algorithm="http://www.w3.org/2001/10/xr
            </ds:Transforms>
            <ds:DigestMethod Algorithm="http://www.w3.org/2001/04/xml
            <ds:DigestValue>...</ds:DigestValue>
          </ds:Reference>
        </ds:SignedInfo>
        <ds:SignatureValue>...</ds:SignatureValue>
        <ds:KeyInfo>
```

```
<ds:KeyName>356b4241808341cc9ff6295a43b01d00daab27406ddcd3f70
</ds:KeyInfo>
</ds:Signature>
<saml2:Subject>
  <saml2:NameID Format="urn:oasis:names:tc:SAML:2.0:nameid-format:t
    6cdd6d85-a822-45cf-98f2-87792ab4c930
  </saml2:NameID>
  <saml2:SubjectConfirmation Method="urn:oasis:names:tc:SAML:2.0:cr
    <saml2:SubjectConfirmationData InResponseTo="_e1234e91b147553
      NotOnOrAfter="2021-10-06T08:11
      Recipient="http://sp.example.c
    </saml2:SubjectConfirmation>
  </saml2:Subject>
<saml2:Conditions NotBefore="2021-10-06T08:07:48.953Z" NotOnOrAfter="
  <saml2:AudienceRestriction>
    <saml2:Audience>urn:n1-eid-gdi:1.0:DV:000000999999999004:en
  </saml2:AudienceRestriction>
</saml2:Conditions>
<saml2:Advice>
  <saml2:Assertion ID="_8de0f8271f4938285bfb6f66541a3b33" IssueInst
    Version="2.0" xmlns:saml2="urn:oasis:names:tc:SA
  <saml2:Issuer>urn:n1-eid-gdi:1.0:AD:000000273813120000:entit
  <ds:Signature xmlns:ds="http://www.w3.org/2000/09/xmlsig#">
    <ds:SignedInfo>
      <ds:CanonicalizationMethod Algorithm="http://www.w3.c
      <ds:SignatureMethod Algorithm="http://www.w3.org/2001
      <ds:Reference URI="#_8de0f8271f4938285bfb6f66541a3b33
        <ds:Transforms>
          <ds:Transform
            Algorithm="http://www.w3.org/2000/09/
          <ds:Transform Algorithm="http://www.w3.org/20
        </ds:Transforms>
      <ds:DigestMethod Algorithm="http://www.w3.org/200
      <ds:DigestValue>...</ds:DigestValue>
    </ds:Reference>
  </ds:SignedInfo>
  <ds:SignatureValue>...</ds:SignatureValue>
  <ds:KeyInfo>
    <ds:KeyName>24b1a2189f8af57114df0b93120f88b1d9cd38a0f
    </ds:KeyName>
  </ds:KeyInfo>
</ds:Signature>
<saml2:Subject>
  <saml2:NameID Format="urn:oasis:names:tc:SAML:2.0:nameid-
    6cdd6d85-a822-45cf-98f2-87792ab4c930
  </saml2:NameID>
  <saml2:SubjectConfirmation Method="urn:oasis:names:tc:SA
    <saml2:SubjectConfirmationData
      InResponseTo="_e1234e91b14755343ff8c69c046cc4
      NotOnOrAfter="2021-10-06T08:11:48.953Z"
      Recipient="http://sp.example.com"/>
    </saml2:SubjectConfirmation>
  </saml2:Subject>
<saml2:Conditions NotBefore="2021-10-06T08:07:48.953Z"
  NotOnOrAfter="2021-10-06T08:11:48.953Z">
  <saml2:AudienceRestriction>
    <saml2:Audience>urn:n1-eid-gdi:1.0:DV:000000999999999
  </saml2:Audience>
  </saml2:AudienceRestriction>
</saml2:Conditions>
<saml2:AuthnStatement AuthnInstant="2021-10-06T08:09:50.300Z"
  <saml2:AuthnContext>
    <saml2:AuthnContextClassRef>http://eid.logius.nl/LoA/
  </saml2:AuthnContextClassRef>
  </saml2:AuthnContext>
</saml2:AuthnStatement>
<saml2:AttributeStatement>
```

```

<saml2:Attribute Name="urn:nl-eid-gdi:1.0:ServiceUUID">
  <saml2:AttributeValue>375b1cb114b7-12e9-3534-16cc-4d8
</saml2:Attribute>
<saml2:Attribute Name="urn:nl-eid-gdi:1.0:ActingSubjectID"
  <saml2:AttributeValue>
    <saml2:EncryptedID>
      <xenc:EncryptedData xmlns:xenc="http://www.w3
        Id="_d0d48b29e94d76c6a0ee
        Type="http://www.w3.org/2
      <xenc:EncryptionMethod
        Algorithm="http://www.w3.org/2001
        xmlns:xenc="http://www.w3.org/200
      <ds:KeyInfo xmlns:ds="http://www.w3.org/2
        <ds:RetrievalMethod
          Type="http://www.w3.org/2001/
          URI="#_ab71ea3bafb606b8a89c47
        </ds:KeyInfo>
      <xenc:CipherData xmlns:xenc="http://www.w
        <xenc:CipherValue>
          5q5RNYI9w79gCyq78PC8Pd3IY7GPaw3yc
        </xenc:CipherValue>
      </xenc:CipherData>
    </xenc:EncryptedData>
    <xenc:EncryptedKey xmlns:xenc="http://www.w3.
      Id="_ab71ea3bafb606b8a89c4
      Recipient="urn:nl-eid-gdi:
    <xenc:EncryptionMethod
      Algorithm="http://www.w3.org/2001
      xmlns:xenc="http://www.w3.org/200
    <ds:DigestMethod xmlns:ds="http://www
      Algorithm="http://ww
    </xenc:EncryptionMethod>
    <ds:KeyInfo xmlns:ds="http://www.w3.org/2
      <ds:KeyName>1d0bc832d839df789eca8bae6
    </ds:KeyInfo>
    <xenc:CipherData xmlns:xenc="http://www.w
      <xenc:CipherValue>
        YoXfK3S0PgipqMg8bvKQ2hD0Wwp6sbWrp
      </xenc:CipherValue>
    </xenc:CipherData>
    <xenc:ReferenceList>
      <xenc:DataReference URI="#_d0d48b29e9
    </xenc:ReferenceList>
    </xenc:EncryptedKey>
  </saml2:EncryptedID>
</saml2:AttributeValue>
</saml2:Attribute>
</saml2:AttributeStatement>
</saml2:Assertion>
</saml2:Advice>
<saml2:AuthnStatement AuthnInstant="2021-10-06T08:09:50.236Z" Session
  <saml2:AuthnContext>
    <saml2:AuthnContextClassRef>http://eid.logius.nl/LoA/basic</s
    <saml2:AuthenticatingAuthority>urn:nl-eid-gdi:1.0:AD:00000002
    </saml2:AuthenticatingAuthority>
  </saml2:AuthnContext>
</saml2:AuthnStatement>
<saml2:AttributeStatement>
  <saml2:Attribute Name="urn:nl-eid-gdi:1.0:ServiceUUID">
    <saml2:AttributeValue>375b1cb114b7-12e9-3534-16cc-4d8997b0</s
  </saml2:Attribute>
  <saml2:Attribute Name="urn:nl-eid-gdi:1.0:ActingSubjectID">
    <saml2:AttributeValue>
      <saml2:EncryptedID>
        <xenc:EncryptedData xmlns:xenc="http://www.w3.org/200
          Id="_91c893eba1c1f87099c1d5a10b87
          Type="http://www.w3.org/2001/04/x

```

```

<xenc:EncryptionMethod Algorithm="http://www.w3.org/2001/04/xmle
xmlns:xenc="http://www.w3.org/2001/04/xml
xmlns:ds="http://www.w3.org/2000/09/x
<ds:KeyInfo xmlns:ds="http://www.w3.org/2000/09/x
  <ds:RetrievalMethod Type="http://www.w3.org/2000/09/x
    URI="#_449673558dd0810e91
  </ds:KeyInfo>
  <xenc:CipherData xmlns:xenc="http://www.w3.org/2001/04/xmle
    <xenc:CipherValue>...</xenc:CipherValue>
  </xenc:CipherData>
</xenc:EncryptedData>
<xenc:EncryptedKey xmlns:xenc="http://www.w3.org/2001/04/xmle
  Id="_449673558dd0810e91009297f56fd
  Recipient="urn:nl-eid-gdi:1.0:DV:0
  <xenc:EncryptionMethod
    Algorithm="http://www.w3.org/2001/04/xmle
    xmlns:xenc="http://www.w3.org/2001/04/xml
    <ds:DigestMethod xmlns:ds="http://www.w3.org/2001/04/xmle
      Algorithm="http://www.w3.org/2001/04/xmle
    </ds:DigestMethod>
  </xenc:EncryptionMethod>
  <ds:KeyInfo xmlns:ds="http://www.w3.org/2000/09/x
    <ds:KeyName>1d0bc832d839df789eca8bae611c3ad7e
  </ds:KeyInfo>
  <xenc:CipherData xmlns:xenc="http://www.w3.org/2001/04/xmle
    <xenc:CipherValue>...</xenc:CipherValue>
  </xenc:CipherData>
  <xenc:ReferenceList
    <xenc:DataReference URI="#_91c893ebalc1f87099
  </xenc:ReferenceList>
</xenc:EncryptedKey>
</saml2:EncryptedID>
</saml2:AttributeValue>
</saml2:Attribute>
</saml2:AttributeStatement>
</saml2:Assertion>
</saml2p:Response>
</saml2p:ArtifactResponse>
</soap11:Body>
</soap11:Envelope>

```

## §A.7 Example - ArtifactResponse with Representation

### EXAMPLE 7: ArtifactResponse with Representation

```
<?xml version="1.0" encoding="UTF-8"?>
<soap11:Envelope xmlns:soap11="http://schemas.xmlsoap.org/soap/envelope/">
  <soap11:Body>
    <saml2p:ArtifactResponse xmlns:saml2p="urn:oasis:names:tc:SAML:2.0:protocol"
      ID="_0fb52522f6e41b750df938ef5ea50154"
      InResponseTo="_1ea090efda5655760b6a0c9dfa8884b66d475222"
      IssueInstant="2021-10-06T08:10:51.018Z" Version="2.0">
      <saml2:Issuer xmlns:saml2="urn:oasis:names:tc:SAML:2.0:assertion">
        urn:nl-eid-gdi:1.0:TD:00000004183317817000:entities:9000
      </saml2:Issuer>
      <ds:Signature xmlns:ds="http://www.w3.org/2000/09/xmldsig#">
        <ds:SignedInfo>
          <ds:CanonicalizationMethod Algorithm="http://www.w3.org/2001/10/xml-e
          <ds:SignatureMethod Algorithm="http://www.w3.org/2001/04/xmldsig-more
          <ds:Reference URI="#_0fb52522f6e41b750df938ef5ea50154">
            <ds:Transforms>
              <ds:Transform Algorithm="http://www.w3.org/2000/09/xmldsig#en
              <ds:Transform Algorithm="http://www.w3.org/2001/10/xml-exc-c1
            </ds:Transforms>
            <ds:DigestMethod Algorithm="http://www.w3.org/2001/04/xmlenc#sha2
            <ds:DigestValue>...</ds:DigestValue>
          </ds:Reference>
        </ds:SignedInfo>
        <ds:SignatureValue>...</ds:SignatureValue>
        <ds:KeyInfo>
          <ds:KeyName>356b4241808341cc9ff6295a43b01d00daab27406ddcd3f708a0a3761
        </ds:KeyInfo>
      </ds:Signature>
    <saml2p:Status>
      <saml2p:StatusCode Value="urn:oasis:names:tc:SAML:2.0:status:Success"/>
    </saml2p:Status>
    <saml2p:Response>
      Destination="sp.example.com"
      ID="_31fa010c6af1bc61583f22c84b3a2b0d" InResponseTo="_a658d2c5c7426b1
      IssueInstant="2021-10-06T08:10:51.018Z" Version="2.0">
      <saml2:Issuer xmlns:saml2="urn:oasis:names:tc:SAML:2.0:assertion">
        urn:nl-eid-gdi:1.0:TD:00000004183317817000:entities:9000
      </saml2:Issuer>
      <saml2p:Status>
        <saml2p:StatusCode Value="urn:oasis:names:tc:SAML:2.0:status:Success"
      </saml2p:Status>
      <saml2:Assertion xmlns:saml2="urn:oasis:names:tc:SAML:2.0:assertion"
        ID="_2a9deaff3a95b2193e74dbad4a69dfbf" IssueInstant="202
        Version="2.0">
      <saml2:Issuer>urn:nl-eid-gdi:1.0:TD:00000004183317817000:entities:900
      <ds:Signature xmlns:ds="http://www.w3.org/2000/09/xmldsig#">
        <ds:SignedInfo>
          <ds:CanonicalizationMethod Algorithm="http://www.w3.org/2001/
          <ds:SignatureMethod Algorithm="http://www.w3.org/2001/04/xmld
          <ds:Reference URI="#_2a9deaff3a95b2193e74dbad4a69dfbf">
            <ds:Transforms>
              <ds:Transform Algorithm="http://www.w3.org/2000/09/xr
              <ds:Transform Algorithm="http://www.w3.org/2001/10/xr
            </ds:Transforms>
            <ds:DigestMethod Algorithm="http://www.w3.org/2001/04/xml
            <ds:DigestValue>...</ds:DigestValue>
          </ds:Reference>
        </ds:SignedInfo>
        <ds:SignatureValue>...</ds:SignatureValue>
        <ds:KeyInfo>
```

```
<ds:KeyName>356b4241808341cc9ff6295a43b01d00daab27406ddcd3f76
</ds:KeyInfo>
</ds:Signature>
<saml2:Subject>
  <saml2:NameID Format="urn:oasis:names:tc:SAML:2.0:nameid-format:t
    45e376c5-78a7-4cdc-a27d-a7dd5056e786
  </saml2:NameID>
  <saml2:SubjectConfirmation Method="urn:oasis:names:tc:SAML:2.0:cr
    <saml2:SubjectConfirmationData InResponseTo="_a658d2c5c7426b1
      NotOnOrAfter="2021-10-06T08:12
      Recipient="http://sp.example.c
    </saml2:SubjectConfirmation>
  </saml2:Subject>
<saml2:Conditions NotBefore="2021-10-06T08:08:50.916Z" NotOnOrAfter="
  <saml2:AudienceRestriction>
    <saml2:Audience>urn:nl-eid-gdi:1.0:DV:000000999999999004:en
  </saml2:AudienceRestriction>
</saml2:Conditions>
<saml2:Advice>
  <saml2:Assertion ID="_797775d153ac85fe682d1c89f668adc1" IssueInst
    Version="2.0" xmlns:saml2="urn:oasis:names:tc:SA
  <saml2:Issuer>urn:nl-eid-gdi:1.0:AD:000000273813120000:entit
  <ds:Signature xmlns:ds="http://www.w3.org/2000/09/xmlsig#">
    <ds:SignedInfo>
      <ds:CanonicalizationMethod Algorithm="http://www.w3.c
      <ds:SignatureMethod Algorithm="http://www.w3.org/2001
      <ds:Reference URI="#_797775d153ac85fe682d1c89f668adc1
        <ds:Transforms>
          <ds:Transform
            Algorithm="http://www.w3.org/2000/09/
          <ds:Transform Algorithm="http://www.w3.org/20
        </ds:Transforms>
      <ds:DigestMethod Algorithm="http://www.w3.org/200
      <ds:DigestValue>...</ds:DigestValue>
    </ds:Reference>
  </ds:SignedInfo>
  <ds:SignatureValue>...</ds:SignatureValue>
  <ds:KeyInfo>
    <ds:KeyName>24b1a2189f8af57114df0b93120f88b1d9cd38a0f
    </ds:KeyName>
  </ds:KeyInfo>
</ds:Signature>
<saml2:Subject>
  <saml2:NameID Format="urn:oasis:names:tc:SAML:2.0:nameid-
    45e376c5-78a7-4cdc-a27d-a7dd5056e786
  </saml2:NameID>
  <saml2:SubjectConfirmation Method="urn:oasis:names:tc:SA
    <saml2:SubjectConfirmationData
      InResponseTo="_a658d2c5c7426b11dfbdbl30d4b0c
      NotOnOrAfter="2021-10-06T08:12:50.916Z"
      Recipient="http://sp.example.com"/>
    </saml2:SubjectConfirmation>
  </saml2:Subject>
<saml2:Conditions NotBefore="2021-10-06T08:08:50.916Z"
  NotOnOrAfter="2021-10-06T08:12:50.916Z">
  <saml2:AudienceRestriction>
    <saml2:Audience>urn:nl-eid-gdi:1.0:DV:000000999999999
  </saml2:Audience>
  </saml2:AudienceRestriction>
</saml2:Conditions>
<saml2:AuthnStatement AuthnInstant="2021-10-06T08:10:51.029Z"
  <saml2:AuthnContext>
    <saml2:AuthnContextClassRef>http://eid.logius.nl/LoA/
  </saml2:AuthnContextClassRef>
  </saml2:AuthnContext>
</saml2:AuthnStatement>
<saml2:AttributeStatement>
```

```

<saml2:Attribute Name="urn:nl-eid-gdi:1.0:ServiceUUID">
  <saml2:AttributeValue>375b1cb114b7-12e9-3534-16cc-4d8
</saml2:Attribute>
<saml2:Attribute Name="urn:nl-eid-gdi:1.1:RepresentationT
  <saml2:AttributeValue>0G0-11</saml2:AttributeValue>
</saml2:Attribute>
<saml2:Attribute Name="urn:nl-eid-gdi:1.0:ActingSubjectID
  <saml2:AttributeValue>
    <saml2:EncryptedID>
      <xenc:EncryptedData xmlns:xenc="http://www.w3
        Id="_e4ed5fc71f364184a43a
        Type="http://www.w3.org/2
      <xenc:EncryptionMethod
        Algorithm="http://www.w3.org/2001
        xmlns:xenc="http://www.w3.org/200
      <ds:KeyInfo xmlns:ds="http://www.w3.org/2
        <ds:RetrievalMethod
          Type="http://www.w3.org/2001/
          URI="#_0ceelf147ad7e995e77e67
        </ds:KeyInfo>
      <xenc:CipherData xmlns:xenc="http://www.w
        <xenc:CipherValue>...</xenc:CipherVal
      </xenc:CipherData>
    </xenc:EncryptedData>
    <xenc:EncryptedKey xmlns:xenc="http://www.w3.
      Id="_0ceelf147ad7e995e77e6
      Recipient="urn:nl-eid-gdi:
    <xenc:EncryptionMethod
      Algorithm="http://www.w3.org/2001
      xmlns:xenc="http://www.w3.org/200
    <ds:DigestMethod xmlns:ds="http://www
      Algorithm="http://ww
    </xenc:EncryptionMethod>
    <ds:KeyInfo xmlns:ds="http://www.w3.org/2
      <ds:KeyName>1d0bc832d839df789eca8bae6
    </ds:KeyInfo>
    <xenc:CipherData xmlns:xenc="http://www.w
      <xenc:CipherValue>...</xenc:CipherVal
    </xenc:CipherData>
    <xenc:ReferenceList>
      <xenc:DataReference URI="#_e4ed5fc71f
    </xenc:ReferenceList>
    </xenc:EncryptedKey>
  </saml2:EncryptedID>
</saml2:AttributeValue>
</saml2:Attribute>
<saml2:Attribute Name="urn:nl-eid-gdi:1.0:LegalSubjectID"
  <saml2:AttributeValue>
    <saml2:EncryptedID>
      <xenc:EncryptedData xmlns:xenc="http://www.w3
        Id="_46e926d560129ac37728
        Type="http://www.w3.org/2
      <xenc:EncryptionMethod
        Algorithm="http://www.w3.org/2001
        xmlns:xenc="http://www.w3.org/200
      <ds:KeyInfo xmlns:ds="http://www.w3.org/2
        <ds:RetrievalMethod
          Type="http://www.w3.org/2001/
          URI="#_0d819bc6f2168e97c83c58
        </ds:KeyInfo>
      <xenc:CipherData xmlns:xenc="http://www.w
        <xenc:CipherValue>...</xenc:CipherVal
      </xenc:CipherData>
    </xenc:EncryptedData>
    <xenc:EncryptedKey xmlns:xenc="http://www.w3.
      Id="_0d819bc6f2168e97c83c5
      Recipient="urn:nl-eid-gdi:

```

```

        <xenc:EncryptionMethod
            Algorithm="http://www.w3.org/2001
            xmlns:xenc="http://www.w3.org/200
            <ds:DigestMethod xmlns:ds="http://www
                Algorithm="http://ww
        </xenc:EncryptionMethod>
        <ds:KeyInfo xmlns:ds="http://www.w3.org/2
            <ds:KeyName>1d0bc832d839df789eca8bae6
        </ds:KeyInfo>
        <xenc:CipherData xmlns:xenc="http://www.w
            <xenc:CipherValue>...</xenc:CipherVal
        </xenc:CipherData>
        <xenc:ReferenceList>
            <xenc:DataReference URI="#_46e926d560
        </xenc:ReferenceList>
        </xenc:EncryptedKey>
    </saml2:EncryptedID>
</saml2:AttributeValue>
</saml2:Attribute>
</saml2:AttributeStatement>
</saml2:Assertion>
<saml2:Assertion ID="_c7a79a0e92311f0d3d2dadc247a855f6" IssueInst
    Version="2.0" xmlns:saml2="urn:oasis:names:tc:SAML:2.0"
    <saml2:Issuer>urn:nl-eid-gdi:1.0:BVD:00000004003214345001:ent
    <ds:Signature xmlns:ds="http://www.w3.org/2000/09/xmldsig#">
        <ds:SignedInfo>
            <ds:CanonicalizationMethod Algorithm="http://www.w3.c
            <ds:SignatureMethod Algorithm="http://www.w3.org/2001
            <ds:Reference URI="#_c7a79a0e92311f0d3d2dadc247a855f6
                <ds:Transforms>
                    <ds:Transform
                        Algorithm="http://www.w3.org/2000/09/
                    <ds:Transform Algorithm="http://www.w3.org/20
                </ds:Transforms>
                <ds:DigestMethod Algorithm="http://www.w3.org/200
                <ds:DigestValue>...</ds:DigestValue>
            </ds:Reference>
        </ds:SignedInfo>
        <ds:SignatureValue>...</ds:SignatureValue>
    </ds:Signature>
    <ds:KeyInfo>
        <ds:KeyName>4202df88ba9faae2d2860a0d821d2bde10babc0a2
        </ds:KeyName>
    </ds:KeyInfo>
</ds:Signature>
<saml2:Subject>
    <saml2:NameID Format="urn:oasis:names:tc:SAML:2.0:nameid-
        45e376c5-78a7-4cdc-a27d-a7dd5056e786
    </saml2:NameID>
    <saml2:SubjectConfirmation Method="urn:oasis:names:tc:SAM
        <saml2:SubjectConfirmationData
            InResponseTo="_a658d2c5c7426b11dfbdb1e30d4b0c
            NotOnOrAfter="2021-10-06T08:12:50.916Z"
            Recipient="http://sp.example.com"/>
        </saml2:SubjectConfirmation>
</saml2:Subject>
<saml2:Conditions NotBefore="2021-10-06T08:08:50.916Z"
    NotOnOrAfter="2021-10-06T08:12:50.916Z">
    <saml2:AudienceRestriction>
        <saml2:Audience>urn:nl-eid-gdi:1.0:DV:000000099999999
        </saml2:Audience>
    </saml2:AudienceRestriction>
</saml2:Conditions>
<saml2:AuthnStatement AuthnInstant="2021-10-06T08:10:51.090Z"
    <saml2:AuthnContext>
        <saml2:AuthnContextClassRef>http://eid.logius.nl/LoA/
        </saml2:AuthnContextClassRef>
    </saml2:AuthnContext>

```

```

</saml2:AuthnStatement>
<saml2:AttributeStatement>
  <saml2:Attribute Name="urn:nl-eid-gdi:1.0:ServiceUUID">
    <saml2:AttributeValue>375b1cb114b7-12e9-3534-16cc-4d8
  </saml2:Attribute>
  <saml2:Attribute Name="urn:nl-eid-gdi:1.0:ActingSubjectID">
    <saml2:AttributeValue>
      <saml2:EncryptedID>
        <xenc:EncryptedData xmlns:xenc="http://www.w3
          Id="_d4eb5b0632d388373948
          Type="http://www.w3.org/2
        <xenc:EncryptionMethod
          Algorithm="http://www.w3.org/2001
          xmlns:xenc="http://www.w3.org/200
        <ds:KeyInfo xmlns:ds="http://www.w3.org/2
          <ds:RetrievalMethod
            Type="http://www.w3.org/2001/
            URI="#_720276d2e729cdec6889f
          </ds:KeyInfo>
        <xenc:CipherData xmlns:xenc="http://www.w
          <xenc:CipherValue>...</xenc:CipherVal
        </xenc:CipherData>
      </xenc:EncryptedData>
      <xenc:EncryptedKey xmlns:xenc="http://www.w3.
        Id="_720276d2e729cdec6889
        Recipient="urn:nl-eid-gdi:
      <xenc:EncryptionMethod
        Algorithm="http://www.w3.org/2001
        xmlns:xenc="http://www.w3.org/200
      <ds:DigestMethod xmlns:ds="http://www
        Algorithm="http://ww
      </xenc:EncryptionMethod>
      <ds:KeyInfo xmlns:ds="http://www.w3.org/2
        <ds:KeyName>1d0bc832d839df789eca8bae6
      </ds:KeyInfo>
      <xenc:CipherData xmlns:xenc="http://www.w
        <xenc:CipherValue>...</xenc:CipherVal
      </xenc:CipherData>
      <xenc:ReferenceList>
        <xenc:DataReference URI="#_d4eb5b0632
      </xenc:ReferenceList>
    </xenc:EncryptedKey>
  </saml2:EncryptedID>
</saml2:AttributeValue>
</saml2:Attribute>
<saml2:Attribute Name="urn:nl-eid-gdi:1.0:LegalSubjectID">
  <saml2:AttributeValue>
    <saml2:EncryptedID>
      <xenc:EncryptedData xmlns:xenc="http://www.w3
        Id="_0fbab7451567b5041390
        Type="http://www.w3.org/2
      <xenc:EncryptionMethod
        Algorithm="http://www.w3.org/2001
        xmlns:xenc="http://www.w3.org/200
      <ds:KeyInfo xmlns:ds="http://www.w3.org/2
        <ds:RetrievalMethod
          Type="http://www.w3.org/2001/
          URI="#_2cab7ef2667689c6064dda
        </ds:KeyInfo>
      <xenc:CipherData xmlns:xenc="http://www.w
        <xenc:CipherValue>...</xenc:CipherVal
      </xenc:CipherData>
    </xenc:EncryptedData>
    <xenc:EncryptedKey xmlns:xenc="http://www.w3.
      Id="_2cab7ef2667689c6064dd
      Recipient="urn:nl-eid-gdi:
    <xenc:EncryptionMethod

```

```

        Algorithm="http://www.w3.org/2001
        xmlns:xenc="http://www.w3.org/200
        <ds:DigestMethod xmlns:ds="http://www
            Algorithm="http://ww
    </xenc:EncryptionMethod>
    <ds:KeyInfo xmlns:ds="http://www.w3.org/2
        <ds:KeyName>1d0bc832d839df789eca8bae6
    </ds:KeyInfo>
    <xenc:CipherData xmlns:xenc="http://www.w
        <xenc:CipherValue>...</xenc:CipherVal
    </xenc:CipherData>
    <xenc:ReferenceList>
        <xenc:DataReference URI="#_0fbab74515
    </xenc:ReferenceList>
    </xenc:EncryptedKey>
    </samL2:EncryptedID>
    </samL2:AttributeValue>
    </samL2:Attribute>
    </samL2:AttributeStatement>
    </samL2:Assertion>
</samL2:Advice>
<samL2:AuthnStatement AuthnInstant="2021-10-06T08:10:51.018Z" Session
    <samL2:AuthnContext>
        <samL2:AuthnContextClassRef>http://eid.logius.nl/LoA/basic</s
        <samL2:AuthenticatingAuthority>urn:nl-eid-gdi:1.0:AD:00000002
    </samL2:AuthenticatingAuthority>
        <samL2:AuthenticatingAuthority>urn:nl-eid-gdi:1.0:BVD:00000000
    </samL2:AuthenticatingAuthority>
    </samL2:AuthnContext>
</samL2:AuthnStatement>
<samL2:AttributeStatement>
    <samL2:Attribute Name="urn:nl-eid-gdi:1.0:ServiceUUID">
        <samL2:AttributeValue>375b1cb114b7-12e9-3534-16cc-4d8997b0</s
    </samL2:Attribute>
    <samL2:Attribute Name="urn:nl-eid-gdi:1.0:ActingSubjectID">
        <samL2:AttributeValue>
            <samL2:EncryptedID>
                <xenc:EncryptedData xmlns:xenc="http://www.w3.org/200
                    Id="_c108a849ffb239e73ac6083348ad
                    Type="http://www.w3.org/2001/04/x
                <xenc:EncryptionMethod Algorithm="http://www.w3.c
                    xmlns:xenc="http://www.w3.
                <ds:KeyInfo xmlns:ds="http://www.w3.org/2000/09/x
                    <ds:RetrievalMethod Type="http://www.w3.org/2
                        URI="#_df56cc944ecbb3a06f
                </ds:KeyInfo>
                <xenc:CipherData xmlns:xenc="http://www.w3.org/20
                    <xenc:CipherValue>...</xenc:CipherValue>
                </xenc:CipherData>
            </xenc:EncryptedData>
            <xenc:EncryptedKey xmlns:xenc="http://www.w3.org/2001
                Id="_df56cc944ecbb3a06fe5d0a0d45aa
                Recipient="urn:nl-eid-gdi:1.0:DV:0
            <xenc:EncryptionMethod
                Algorithm="http://www.w3.org/2001/04/xmle
                xmlns:xenc="http://www.w3.org/2001/04/xml
            <ds:DigestMethod xmlns:ds="http://www.w3.org/
                Algorithm="http://www.w3.org
            </xenc:EncryptionMethod>
            <ds:KeyInfo xmlns:ds="http://www.w3.org/2000/09/x
                <ds:KeyName>1d0bc832d839df789eca8bae611c3ad7e
            </ds:KeyInfo>
            <xenc:CipherData xmlns:xenc="http://www.w3.org/20
                <xenc:CipherValue>...</xenc:CipherValue>
            </xenc:CipherData>
            <xenc:ReferenceList>
                <xenc:DataReference URI="#_c108a849ffb239e73a

```

```

        </xenc:ReferenceList>
      </xenc:EncryptedKey>
    </saml2:EncryptedID>
  </saml2:AttributeValue>
</saml2:Attribute>
<saml2:Attribute Name="urn:n1-eid-gdi:1.0:LegalSubjectID">
  <saml2:AttributeValue>
    <saml2:EncryptedID>
      <xenc:EncryptedData xmlns:xenc="http://www.w3.org/200
        Id="_5d50f7898d8afda532502d7f82e4
        Type="http://www.w3.org/2001/04/x
      <xenc:EncryptionMethod Algorithm="http://www.w3.c
        xmlns:xenc="http://www.w3.
      <ds:KeyInfo xmlns:ds="http://www.w3.org/2000/09/x
        <ds:RetrievalMethod Type="http://www.w3.org/2
          URI="#_ea31225223bb330ed5
        </ds:KeyInfo>
      <xenc:CipherData xmlns:xenc="http://www.w3.org/20
        <xenc:CipherValue>...</xenc:CipherValue>
      </xenc:CipherData>
    </xenc:EncryptedData>
    <xenc:EncryptedKey xmlns:xenc="http://www.w3.org/2001
      Id="_ea31225223bb330ed5fe42bb55f01
      Recipient="urn:n1-eid-gdi:1.0:DV:0
    <xenc:EncryptionMethod
      Algorithm="http://www.w3.org/2001/04/xmle
      xmlns:xenc="http://www.w3.org/2001/04/xml
    <ds:DigestMethod xmlns:ds="http://www.w3.org/
      Algorithm="http://www.w3.org
    </xenc:EncryptionMethod>
    <ds:KeyInfo xmlns:ds="http://www.w3.org/2000/09/x
      <ds:KeyName>1d0bc832d839df789eca8bae611c3ad7e
    </ds:KeyInfo>
    <xenc:CipherData xmlns:xenc="http://www.w3.org/20
      <xenc:CipherValue>...</xenc:CipherValue>
    </xenc:CipherData>
    <xenc:ReferenceList>
      <xenc:DataReference URI="#_5d50f7898d8afda532
    </xenc:ReferenceList>
  </xenc:EncryptedKey>
</saml2:EncryptedID>
</saml2:AttributeValue>
</saml2:Attribute>
</saml2:AttributeStatement>
</saml2:Assertion>
</saml2p:Response>
</saml2p:ArtifactResponse>
</soap11:Body>
</soap11:Envelope>

```

## §A.8 Example - LogoutRequest

### EXAMPLE 8: LogoutRequest

```
<?xml version="1.0" encoding="UTF-8"?>
<samlp:LogoutRequest Destination="http://idp.example.com/request_logout"
  ID="_2c952f14396dbab5f8c214d074e8e51272de9faa" IssueInstant="2021-10
  xmlns:ds="http://www.w3.org/2000/09/xmldsig#" xmlns:ec="http://www.w
  xmlns:saml="urn:oasis:names:tc:SAML:2.0:assertion"
  xmlns:samlp="urn:oasis:names:tc:SAML:2.0:protocol">
  <saml:Issuer>urn:nl-eid-gdi:1.0:DV:00000009999999999004:entities:0000</saml:Issuer>
  <ds:Signature>
    <ds:SignedInfo>
      <ds:CanonicalizationMethod Algorithm="http://www.w3.org/2001/10/xml-exc-c14n#
      <ds:SignatureMethod Algorithm="http://www.w3.org/2001/04/xmldsig-more#rsa-sha
      <ds:Reference URI="#_2c952f14396dbab5f8c214d074e8e51272de9faa">
        <ds:Transforms>
          <ds:Transform Algorithm="http://www.w3.org/2000/09/xmldsig#enveloped-
          <ds:Transform Algorithm="http://www.w3.org/2001/10/xml-exc-c14n#">
            <ec:InclusiveNamespaces PrefixList="ds saml samlp xs"/>
          </ds:Transform>
        </ds:Transforms>
        <ds:DigestMethod Algorithm="http://www.w3.org/2001/04/xmenc#sha256"/>
        <ds:DigestValue>...</ds:DigestValue>
      </ds:Reference>
    </ds:SignedInfo>
    <ds:SignatureValue>...</ds:SignatureValue>
    <ds:KeyInfo>
      <ds:KeyName>1d0bc832d839df789eca8bae611c3ad7ec5c5074</ds:KeyName>
    </ds:KeyInfo>
  </ds:Signature>
  <saml:SessionIndex>45e376c5-78a7-4cdc-a27d-a7dd5056e786</saml:SessionIndex>
  <saml:NameID>45e376c5-78a7-4cdc-a27d-a7dd5056e786</saml:NameID>
</samlp:LogoutRequest>
```

## §A.9 Example - LogoutResponse

### EXAMPLE 9: LogoutResponse

```
<?xml version="1.0" encoding="UTF-8"?>
<samlp:LogoutResponse xmlns:samlp="urn:oasis:names:tc:SAML:2.0:protocol"
    xmlns:saml="urn:oasis:names:tc:SAML:2.0:assertion" xmlns:ds="http://
    ID="_1d0f30ecbc082449c36286d14063dcb4" Version="2.0" IssueInstant="
    Destination="http://idp.example.com/single_logout_service"
    InResponseTo="_4565109c3326bc3ab8c680d8efeaba7e22b7e304">
  <saml:Issuer>urn:nl-eid-gdi:1.0:TD:00000004183317817000:entities:9000</saml:Issuer>
  <ds:Signature>
    <ds:SignedInfo>
      <ds:CanonicalizationMethod Algorithm="http://www.w3.org/2001/10/xml-exc-c14n#
      <ds:SignatureMethod Algorithm="http://www.w3.org/2001/04/xmldsig-more#rsa-sha
      <ds:Reference URI="#_1d0f30ecbc082449c36286d14063dcb4">
        <ds:Transforms>
          <ds:Transform Algorithm="http://www.w3.org/2000/09/xmldsig#enveloped-
          <ds:Transform Algorithm="http://www.w3.org/2001/10/xml-exc-c14n#" />
        </ds:Transforms>
        <ds:DigestMethod Algorithm="http://www.w3.org/2001/04/xmldsig-more#sha256" />
        <ds:DigestValue>...</ds:DigestValue>
      </ds:Reference>
    </ds:SignedInfo>
    <ds:SignatureValue>...</ds:SignatureValue>
    <ds:KeyInfo>
      <ds:KeyName>24b1a2189f8af57114df0b93120f88b1d9cd38a0f06780377f6f8ace82fb0b18<
    </ds:KeyInfo>
  </ds:Signature>
  <samlp:Status>
    <samlp:StatusCode Value="urn:oasis:names:tc:SAML:2.0:status:Success" />
  </samlp:Status>
</samlp:LogoutResponse>
```

## §B. Example SAML metadata

*This section is non-normative.*

## §B.1 Example - Metadata DV for RD

### EXAMPLE 10: SAML metadata DV for RD

```
<md:EntityDescriptor xmlns:md="urn:oasis:names:tc:SAML:2.0:metadata"
  xmlns:saml="urn:oasis:names:tc:SAML:2.0:assertion"
  xmlns:dsig="http://www.w3.org/2000/09/xmldsig#"
  xmlns:xsi="http://www.w3.org/2001/XMLSchema-instance"
  xmlns:xs="http://www.w3.org/2001/XMLSchema"
  ID="_d611bce3fb2b4ee587bd508acfb89f2f1154815b"
  entityID="urn:nl-eid-gdi:1.0:DV:00000004000000010000:entities:9002"
  validUntil="2021-03-03T10:00:00Z"
>
  <dsig:Signature xmlns:dsig="http://www.w3.org/2000/09/xmldsig#">
    <dsig:SignedInfo>
      <dsig:CanonicalizationMethod
        Algorithm="http://www.w3.org/2001/10/xml-exc-c14n#" />
      <dsig:SignatureMethod
        Algorithm="http://www.w3.org/2001/04/xmldsig-more#rsa-sha256" />
      <dsig:Reference
        URI="#_d611bce3fb2b4ee587bd508acfb89f2f1154815b">
        <dsig:Transforms>
          <dsig:Transform
            Algorithm="http://www.w3.org/2000/09/xmldsig#enveloped-signat
          <dsig:Transform
            Algorithm="http://www.w3.org/2001/10/xml-exc-c14n#" />
          </dsig:Transforms>
          <dsig:DigestMethod
            Algorithm="http://www.w3.org/2001/04/xmldsig-more#sha256" />
          <dsig:DigestValue>...</dsig:DigestValue>
        </dsig:Reference>
      </dsig:SignedInfo>
      <dsig:SignatureValue>...</dsig:SignatureValue>
      <dsig:KeyInfo>
        <dsig:X509Data>
          <dsig:X509Certificate>...</dsig:X509Certificate>
        </dsig:X509Data>
      </dsig:KeyInfo>
    </dsig:Signature>
    <md:SPSSODescriptor AuthnRequestsSigned="true" WantAssertionsSigned="true"
      protocolSupportEnumeration="urn:oasis:names:tc:SAML:2.0:protocol"
    >
      <md:KeyDescriptor use="signing">
        <dsig:KeyInfo>
          <dsig:KeyName>dec5ed105fc56a8a6b85f83d1a4e7b64af0eb378</dsig:KeyName>
          <dsig:X509Data>
            <dsig:X509Certificate>...</dsig:X509Certificate>
          </dsig:X509Data>
        </dsig:KeyInfo>
      </md:KeyDescriptor>
      <md:KeyDescriptor use="encryption">
        <dsig:KeyInfo>
          <dsig:KeyName>cdb948c5dfde5c9a53bf4916763dc973d55e8dd0</dsig:KeyName>
          <dsig:X509Data>
            <dsig:X509Certificate>...</dsig:X509Certificate>
          </dsig:X509Data>
        </dsig:KeyInfo>
      </md:KeyDescriptor>
      <md:SingleLogoutService
        Binding="urn:oasis:names:tc:SAML:2.0:bindings:HTTP-POST"
        Location="https://login.dv.test/saml/sp/logout" />
      <md:AssertionConsumerService
        Binding="urn:oasis:names:tc:SAML:2.0:bindings:HTTP-Artifact"
        Location="https://login.dv.test/saml/sp/acs" index="0" isDefault="true" />
      <md:AttributeConsumingService index="0" isDefault="true">
```

```
<md:ServiceName xml:lang="nl-NL">Dienstnaam 1</md:ServiceName>
<md:RequestedAttribute Name="urn:nl-eid-gdi:1.0:ServiceUUID">
  <saml:AttributeValue xsi:type="xs:string">f847dc11-ac24-47b2-
    84a8-a057440ce56d
  </saml:AttributeValue>
</md:RequestedAttribute>
</md:AttributeConsumingService>
</md:SPSSODescriptor>
</md:EntityDescriptor>
```

## §B.2 Example - Metadata LC for RD

### EXAMPLE 11: SAML metadata LC for RD

```
<md:EntitiesDescriptor xmlns:md="urn:oasis:names:tc:SAML:2.0:metadata"
  xmlns:dsig="http://www.w3.org/2000/09/xmldsig#"
  ID="_e611bce3fb2b4ee587bd508acfb89f2f1154815c"
  validUntil="2021-03-03T10:00:00Z"
>
  <dsig:Signature xmlns:dsig="http://www.w3.org/2000/09/xmldsig#">
    <dsig:SignedInfo>
      <dsig:CanonicalizationMethod
        Algorithm="http://www.w3.org/2001/10/xml-exc-c14n#" />
      <dsig:SignatureMethod
        Algorithm="http://www.w3.org/2001/04/xmldsig-more#rsa-sha256" />
      <dsig:Reference
        URI="#_e611bce3fb2b4ee587bd508acfb89f2f1154815c">
        <dsig:Transforms>
          <dsig:Transform
            Algorithm="http://www.w3.org/2000/09/xmldsig#enveloped-signat
          <dsig:Transform
            Algorithm="http://www.w3.org/2001/10/xml-exc-c14n#" />
          </dsig:Transforms>
          <dsig:DigestMethod
            Algorithm="http://www.w3.org/2001/04/xmldsig-more#sha256" />
          <dsig:DigestValue>...</dsig:DigestValue>
        </dsig:Reference>
      </dsig:SignedInfo>
      <dsig:SignatureValue>...</dsig:SignatureValue>
      <dsig:KeyInfo>
        <dsig:X509Data>
          <dsig:X509Certificate>...</dsig:X509Certificate>
        </dsig:X509Data>
      </dsig:KeyInfo>
    </dsig:Signature>
    <md:EntityDescriptor xmlns:md="urn:oasis:names:tc:SAML:2.0:metadata"
      xmlns:dsig="http://www.w3.org/2000/09/xmldsig#"
      ID="_5d9c0e0ccb144714937dabffbf36e90ee57ee8ea"
      entityID="urn:n1-eid-gdi:1.0:LC:0000008000000020000:entities:90
      validUntil="2021-03-03T10:00:00Z"
    >
      <md:SPSSODescriptor AuthnRequestsSigned="true" WantAssertionsSigned="true"
        protocolSupportEnumeration="urn:oasis:names:tc:SAML:2.0:proto
      <md:KeyDescriptor use="signing">
        <dsig:KeyInfo>
          <dsig:KeyName>5138f7018e8a9f81dade8cf0e554134c4cefaf06</dsig:KeyName>
          <dsig:X509Data>
            <dsig:X509Certificate>...</dsig:X509Certificate>
          </dsig:X509Data>
        </dsig:KeyInfo>
      </md:KeyDescriptor>
      <md:KeyDescriptor use="signing">
        <dsig:KeyInfo>
          <dsig:KeyName>6cfed4024668054e3cbf327c060aed4b050e0e7e</dsig:KeyName>
          <dsig:X509Data>
            <dsig:X509Certificate>...</dsig:X509Certificate>
          </dsig:X509Data>
        </dsig:KeyInfo>
      </md:KeyDescriptor>
      <md:SingleLogoutService
        Binding="urn:oasis:names:tc:SAML:2.0:bindings:HTTP-POST"
        Location="https://login.lc.test/saml/sp/logout" />
      <md:AssertionConsumerService
        Binding="urn:oasis:names:tc:SAML:2.0:bindings:HTTP-Artifact"
```

```
Location="https://login.lc.test/saml/sp/acs" index="0" isDefault="tru
  </md:SPSSODescriptor>
</md:EntityDescriptor>
<md:EntityDescriptor xmlns:md="urn:oasis:names:tc:SAML:2.0:metadata"
  xmlns:dsig="http://www.w3.org/2000/09/xmldsig#"
  ID="_d611bce3fb2b4ee587bd508acfb89f2f1154815b"
  entityID="urn:n1-eid-gdi:1.0:DV:00000004000000010000:entities:90
  validUntil="2021-03-03T10:00:00Z"
>
  <md:SPSSODescriptor AuthnRequestsSigned="true" WantAssertionsSigned="true"
    protocolSupportEnumeration="urn:oasis:names:tc:SAML:2.0:proto
  <md:KeyDescriptor use="encryption">
    <dsig:KeyInfo>
      <dsig:KeyName>cdb948c5dfde5c9a53bf4916763dc973d55e8dd0</dsig:KeyName>
      <dsig:X509Data>
        <dsig:X509Certificate>...</dsig:X509Certificate>
      </dsig:X509Data>
    </dsig:KeyInfo>
  </md:KeyDescriptor>
  <md:AssertionConsumerService
    Binding="urn:oasis:names:tc:SAML:2.0:bindings:HTTP-Artifact"
    Location="https://login.lc.test/saml/sp/acs" index="0" isDefault="tru
  </md:SPSSODescriptor>
</md:EntityDescriptor>
<md:EntityDescriptor xmlns:md="urn:oasis:names:tc:SAML:2.0:metadata"
  xmlns:dsig="http://www.w3.org/2000/09/xmldsig#"
  ID="_c611bce3fb2b4ee587bd508acfb89f2f1154815a"
  entityID="urn:n1-eid-gdi:1.0:DV:00000004000000020000:entities:90
  validUntil="2021-03-03T10:00:00Z"
>
  <md:SPSSODescriptor AuthnRequestsSigned="true" WantAssertionsSigned="true"
    protocolSupportEnumeration="urn:oasis:names:tc:SAML:2.0:proto
  <md:KeyDescriptor use="encryption">
    <dsig:KeyInfo>
      <dsig:KeyName>b459clecee731f2be4f50f68abe9bb070b5e2509</dsig:KeyName>
      <dsig:X509Data>
        <dsig:X509Certificate>...</dsig:X509Certificate>
      </dsig:X509Data>
    </dsig:KeyInfo>
  </md:KeyDescriptor>
  <md:KeyDescriptor use="encryption">
    <dsig:KeyInfo>
      <dsig:KeyName>45214df11fbed62751adf608d768f65d7fcd1e25</dsig:KeyName>
      <dsig:X509Data>
        <dsig:X509Certificate>...</dsig:X509Certificate>
      </dsig:X509Data>
    </dsig:KeyInfo>
  </md:KeyDescriptor>
  <md:AssertionConsumerService
    Binding="urn:oasis:names:tc:SAML:2.0:bindings:HTTP-Artifact"
    Location="https://login.lc.test/saml/sp/acs" index="0" isDefault="tru
  </md:SPSSODescriptor>
</md:EntityDescriptor>
</md:EntitiesDescriptor>
```

## §B.3 Example - Metadata RD for DV

### EXAMPLE 12: SAML metadata RD for DV

```
<md:EntityDescriptor xmlns:md="urn:oasis:names:tc:SAML:2.0:metadata"
  xmlns:dsig="http://www.w3.org/2000/09/xmldsig#"
  ID="_c92a6365a0d0ff7e3187ef1ca6cc14918f390db3"
  entityID="urn:nl-eid-gdi:1.0:RD:00000004000000149000:entities:9002"
  validUntil="2021-05-01T12:00:00Z">
  <dsig:Signature xmlns:dsig="http://www.w3.org/2000/09/xmldsig#" Id="Id000159766399661"
    <dsig:SignedInfo>
      <dsig:CanonicalizationMethod
        Algorithm="http://www.w3.org/2001/10/xml-exc-c14n#" />
      <dsig:SignatureMethod
        Algorithm="http://www.w3.org/2001/04/xmldsig-more#rsa-sha256" />
      <dsig:Reference
        URI="#_c92a6365a0d0ff7e3187ef1ca6cc14918f390db3">
        <dsig:Transforms>
          <dsig:Transform
            Algorithm="http://www.w3.org/2000/09/xmldsig#enveloped-signat" />
          <dsig:Transform
            Algorithm="http://www.w3.org/2001/10/xml-exc-c14n#" />
        </dsig:Transforms>
        <dsig:DigestMethod
          Algorithm="http://www.w3.org/2001/04/xmenc#sha256" />
        <dsig:DigestValue>...</dsig:DigestValue>
      </dsig:Reference>
    </dsig:SignedInfo>
    <dsig:SignatureValue>...</dsig:SignatureValue>
    <dsig:KeyInfo xmlns:dsig="http://www.w3.org/2000/09/xmldsig#" Id="Id0001597663996"
      <dsig:KeyName>07c3d08bc6c3303a85c5e0c9547dfd91047f7c58</dsig:KeyName>
    </dsig:KeyInfo>
  </dsig:Signature>
  <md:IDPSSODescriptor WantAuthnRequestsSigned="true"
    protocolSupportEnumeration="urn:oasis:names:tc:SAML:2.0:protocol"
    <md:KeyDescriptor use="signing">
      <dsig:KeyInfo>
        <dsig:KeyName>07c3d08bc6c3303a85c5e0c9547dfd91047f7c58</dsig:KeyName>
        <dsig:X509Data>
          <dsig:X509Certificate>...</dsig:X509Certificate>
        </dsig:X509Data>
      </dsig:KeyInfo>
    </md:KeyDescriptor>
    <md:ArtifactResolutionService
      Binding="urn:oasis:names:tc:SAML:2.0:bindings:SOAP"
      Location="https://artifact-pp2.toegang.overheid.nl/kvs/rd/resolve_artifact
        index="0" />
    <md:SingleLogoutService
      Binding="urn:oasis:names:tc:SAML:2.0:bindings:HTTP-POST"
      Location="https://pp2.toegang.overheid.nl/kvs/rd/request_logout" />
    <md:SingleSignOnService
      Binding="urn:oasis:names:tc:SAML:2.0:bindings:HTTP-POST"
      Location="https://pp2.toegang.overheid.nl/kvs/rd/request_authentication" />
  </md:IDPSSODescriptor>
</md:EntityDescriptor>
```

## §C. List of Figures

Figure 1 Stelsel Toegang SAML1.0

- [Figure 2 Authentication and representation flow - overview](#)
- [Figure 3 SAML Federated Logout overview](#)
- [Figure 4 SAML authentication flow RD - AD/BVD](#)
- [Figure 5 Single Logout RD - AD/BVD](#)
- [Figure 6 SAML authentication flow - DV/LC - RD](#)
- [Figure 7 SAML authentication flow - DV/LC - RD - AuthN-Request](#)
- [Figure 8 SAML authentication flow - DV/LC - RD - Artifact Response](#)
- [Figure 9 SAML authentication flow - DV/LC - RD - Artifact Resolve](#)
- [Figure 10 SAML authentication flow - DV/LC - RD - Artifact Response](#)
- [Figure 11 SAML authentication flow RD - AD/BVD](#)
- [Figure 12 SAML authentication flow - RD - AD/BVD - AuthN-Request](#)
- [Figure 13 SAML authentication flow - RD - AD/BVD Artifact Binding](#)
- [Figure 14 SAML authentication flow - RD - AD/BVD Artifact Resolve](#)
- [Figure 15 SAML authentication flow - RD - AD/BVD Artifact Response](#)
- [Figure 16 LogoutRequest DV/LC - RD](#)
- [Figure 17 LogoutResponse DV/LC - RD](#)
- [Figure 18 Logout Response RD -AD](#)
- [Figure 19 Logout Response RD -AD](#)

## §D. Index

### §D.1 Terms defined by this specification

<a href="#">ActingSubjectID</a> §7.1.2.4.6.2	<a href="#">AttributeConsumingService</a> §8.2.1	Binding
<a href="#">AD</a> §3.2	<a href="#">AttributeConsumingServiceIndex</a> §7.1.2.1.2	<a href="#">definition of</a> §8.2.1
<a href="#">Advice</a> §7.1.2.4.4	AttributeStatement	<a href="#">definition of</a> §8.2.2.1
<a href="#">Artifact</a> §3.1	<a href="#">definition of</a> §7.1.2.4.4	<a href="#">definition of</a> §8.2.3
ArtifactResolutionService	<a href="#">definition of</a> §7.1.2.4.5	<a href="#">definition of</a> §8.2.3
<a href="#">definition of</a> §8.2.3	AttributeValue	<a href="#">definition of</a> §8.2.3
<a href="#">definition of</a> §8.3.2	<a href="#">definition of</a> §7.1.2.4.5	<a href="#">definition of</a> §8.3.1.1
Assertion	<a href="#">definition of</a> §8.2.1	<a href="#">definition of</a> §8.3.1.1
<a href="#">definition of</a> §3.1	<a href="#">Audience</a> §7.1.2.4.4	<a href="#">definition of</a> §8.3.2
<a href="#">definition of</a> §7.1.2.4.3	<a href="#">AudienceRestriction</a> §7.1.2.4.4	<a href="#">definition of</a> §8.3.2
<a href="#">definition of</a> §7.1.2.4.4	<a href="#">AuthenticatingAuthority</a> §7.1.2.4.4	<a href="#">definition of</a> §8.3.2
AssertionConsumerService	<a href="#">AuthnContext</a> §7.1.2.4.4	<a href="#">BVD</a> §3.2
<a href="#">definition of</a> §8.2.1	<a href="#">AuthnContextClassRef</a> §7.1.2.4.4	<a href="#">BVD-DDM</a> §3.1
<a href="#">definition of</a> §8.2.2.1	<a href="#">AuthnInstant</a> §7.1.2.4.4	<a href="#">BVD-OG</a> §3.1
<a href="#">definition of</a> §8.2.2.2	AuthnRequestsSigned	cacheDuration
<a href="#">definition of</a> §8.3.1.1	<a href="#">definition of</a> §8.2.1	<a href="#">definition of</a> §8.2.1
<a href="#">definition of</a> §8.3.1.2	<a href="#">definition of</a> §8.2.2.1	<a href="#">definition of</a> §8.2.2
<a href="#">AssertionConsumerServiceIndex</a> §7.1.2.1.2	<a href="#">definition of</a> §8.3.1.1	<a href="#">definition of</a> §8.2.2.1
Attribute	<a href="#">AuthnStatement</a> §7.1.2.4.4	<a href="#">definition of</a> §8.2.2.2
<a href="#">definition of</a> §7.1.2.1.2	<a href="#">Back channel</a> §3.1	<a href="#">definition of</a> §8.2.3
<a href="#">definition of</a> §7.1.2.1.2		<a href="#">definition of</a> §8.3.1.2
<a href="#">definition of</a> §7.1.2.1.2		<a href="#">Conditions</a> §7.1.2.4.4
<a href="#">definition of</a> §7.1.2.4.5		

<a href="#">Destination</a>	<a href="#">ID</a>	<a href="#">Issuer</a>
<a href="#">definition of §7.1.2.1.2</a>	<a href="#">definition of §7.1.2.1.2</a>	<a href="#">definition of §7.1.2.1.2</a>
<a href="#">definition of §7.1.2.3.2</a>	<a href="#">definition of §7.1.2.3.2</a>	<a href="#">definition of §7.1.2.3.2</a>
<a href="#">definition of §7.1.2.4.3</a>	<a href="#">definition of §7.1.2.4.2</a>	<a href="#">definition of §7.1.2.4.2</a>
<a href="#">definition of §7.3.1.3</a>	<a href="#">definition of §7.1.2.4.3</a>	<a href="#">definition of §7.1.2.4.3</a>
<a href="#">definition of §7.3.1.5</a>	<a href="#">definition of §7.1.2.4.4</a>	<a href="#">definition of §7.1.2.4.4</a>
<a href="#">DigiID §3.1</a>	<a href="#">definition of §7.3.1.3</a>	<a href="#">definition of §7.3.1.3</a>
<a href="#">DigiID-CC §3.1</a>	<a href="#">definition of §7.3.1.5</a>	<a href="#">definition of §7.3.1.5</a>
<a href="#">DigiID-Machtigen §3.1</a>	<a href="#">definition of §8.2.1</a>	<a href="#">KeyDescriptor</a>
<a href="#">DV §3.2</a>	<a href="#">definition of §8.2.2</a>	<a href="#">definition of §8.2.1</a>
<a href="#">EB §3.2</a>	<a href="#">definition of §8.2.2.1</a>	<a href="#">definition of §8.2.2.1</a>
<a href="#">EncryptedAssertion §7.1.2.4.3</a>	<a href="#">definition of §8.2.2.2</a>	<a href="#">definition of §8.2.2.2</a>
<a href="#">EncryptedData §7.1.2.4.6</a>	<a href="#">definition of §8.2.3</a>	<a href="#">definition of §8.2.3</a>
<a href="#">EncryptedID §7.1.2.4.6</a>	<a href="#">definition of §8.3.1</a>	<a href="#">definition of §8.3.1.1</a>
<a href="#">EncryptedKey §7.1.2.4.6</a>	<a href="#">definition of §8.3.1.1</a>	<a href="#">definition of §8.3.1.2</a>
<a href="#">EntitiesDescriptor</a>	<a href="#">definition of §8.3.1.2</a>	<a href="#">definition of §8.3.2</a>
<a href="#">definition of §8.2.2</a>	<a href="#">definition of §8.3.2</a>	<a href="#">KeyInfo</a>
<a href="#">definition of §8.3.1</a>	<a href="#">IDPEntry §7.1.2.1.2</a>	<a href="#">definition of §8.2.1</a>
<a href="#">EntityDescriptor</a>	<a href="#">IDPList §7.1.2.1.2</a>	<a href="#">definition of §8.2.2.1</a>
<a href="#">definition of §8.2.1</a>	<a href="#">IDPSSODescriptor</a>	<a href="#">definition of §8.2.2.2</a>
<a href="#">definition of §8.2.2</a>	<a href="#">definition of §8.2.3</a>	<a href="#">definition of §8.2.3</a>
<a href="#">definition of §8.2.2.1</a>	<a href="#">definition of §8.3.2</a>	<a href="#">definition of §8.3.1.1</a>
<a href="#">definition of §8.2.2.2</a>	<a href="#">Index</a>	<a href="#">definition of §8.3.1.2</a>
<a href="#">definition of §8.2.3</a>	<a href="#">definition of §8.2.1</a>	<a href="#">definition of §8.3.2</a>
<a href="#">definition of §8.3.1</a>	<a href="#">definition of §8.2.2.1</a>	<a href="#">KeyName</a>
<a href="#">definition of §8.3.1.1</a>	<a href="#">definition of §8.2.3</a>	<a href="#">definition of §8.2.1</a>
<a href="#">definition of §8.3.1.2</a>	<a href="#">definition of §8.3.1.1</a>	<a href="#">definition of §8.2.2.1</a>
<a href="#">definition of §8.3.2</a>	<a href="#">definition of §8.3.2</a>	<a href="#">definition of §8.2.2.2</a>
<a href="#">entityID</a>	<a href="#">InResponseTo</a>	<a href="#">definition of §8.2.3</a>
<a href="#">definition of §8.2.1</a>	<a href="#">definition of §7.1.2.4.2</a>	<a href="#">definition of §8.3.1.1</a>
<a href="#">definition of §8.2.2.1</a>	<a href="#">definition of §7.1.2.4.3</a>	<a href="#">definition of §8.3.1.2</a>
<a href="#">definition of §8.2.2.2</a>	<a href="#">definition of §7.1.2.4.4.3</a>	<a href="#">definition of §8.3.2</a>
<a href="#">definition of §8.2.3</a>	<a href="#">definition of §7.3.1.5</a>	<a href="#">LC §3.2</a>
<a href="#">definition of §8.3.1.1</a>	<a href="#">isDefault</a>	<a href="#">Legal Representation §3.1</a>
<a href="#">definition of §8.3.1.2</a>	<a href="#">definition of §8.2.1</a>	<a href="#">LegalSubjectID §7.1.2.4.6.2</a>
<a href="#">definition of §8.3.2</a>	<a href="#">definition of §8.2.2.1</a>	<a href="#">LoA §3.1</a>
<a href="#">EntityID §3.1</a>	<a href="#">definition of §8.3.1.1</a>	<a href="#">Location</a>
<a href="#">ETD §3.1</a>	<a href="#">IssueInstant</a>	<a href="#">definition of §8.2.1</a>
<a href="#">EU §3.2</a>	<a href="#">definition of §7.1.2.1.2</a>	<a href="#">definition of §8.2.2.1</a>
<a href="#">Extensions §7.1.2.1.2</a>	<a href="#">definition of §7.1.2.3.2</a>	<a href="#">definition of §8.2.2.1</a>
<a href="#">ForceAuthn §7.1.2.1.2</a>	<a href="#">definition of §7.1.2.4.2</a>	<a href="#">definition of §8.2.3</a>
<a href="#">Front channel §3.1</a>	<a href="#">definition of §7.1.2.4.3</a>	<a href="#">definition of §8.2.3</a>
<a href="#">Glossary §3.</a>	<a href="#">definition of §7.1.2.4.4</a>	<a href="#">definition of §8.2.3</a>
	<a href="#">definition of §7.3.1.3</a>	<a href="#">definition of §8.3.1.1</a>
	<a href="#">definition of §7.3.1.5</a>	<a href="#">definition of §8.3.1.1</a>
		<a href="#">definition of §8.3.2</a>
		<a href="#">definition of §8.3.2</a>
		<a href="#">definition of §8.3.2</a>
		<a href="#">definition of §8.3.2</a>
		<a href="#">Metadata §3.1</a>
		<a href="#">Method §7.1.2.4.4.3</a>
		<a href="#">Name §7.1.2.4.5</a>

NameID	Signature	<a href="#">SubjectConfirmationData</a> §7.1.2.4.4.3
<a href="#">definition of</a> §7.1.2.4.4	<a href="#">definition of</a> §7.1.2.1.2	<a href="#">Terms</a> §3.1
<a href="#">definition of</a> §7.3.1.3	<a href="#">definition of</a> §7.1.2.3.2	<a href="#">TVS</a> §3.1
<a href="#">NotBefore</a> §7.1.2.4.4	<a href="#">definition of</a> §7.1.2.4.2	<a href="#">UA</a> §3.2
NotOnOrAfter	<a href="#">definition of</a> §7.1.2.4.3	<a href="#">urn:oasis:names:tc:SAML:2.0:status:AuthnFailed</a> §7.4.2
<a href="#">definition of</a> §7.1.2.4.4	<a href="#">definition of</a> §7.1.2.4.4	<a href="#">urn:oasis:names:tc:SAML:2.0:status:NoAuthnContext</a> §7.4.2
<a href="#">definition of</a> §7.1.2.4.4.3	<a href="#">definition of</a> §7.3.1.3	<a href="#">urn:oasis:names:tc:SAML:2.0:status:NoSupportedIDP</a> §7.4.2
<a href="#">Participant</a> §3.1	<a href="#">definition of</a> §7.3.1.5	<a href="#">urn:oasis:names:tc:SAML:2.0:status:RequestDenied</a> §7.4.2
protocolSupportEnumeration	<a href="#">definition of</a> §8.2.1	<a href="#">urn:oasis:names:tc:SAML:2.0:status:Requester</a> §7.4.1
<a href="#">definition of</a> §8.2.1	<a href="#">definition of</a> §8.2.2	<a href="#">urn:oasis:names:tc:SAML:2.0:status:RequestUnsupported</a> §7.4.2
<a href="#">definition of</a> §8.2.2.1	<a href="#">definition of</a> §8.2.2.1	<a href="#">urn:oasis:names:tc:SAML:2.0:status:Requester</a> §7.4.1
<a href="#">definition of</a> §8.2.2.2	<a href="#">definition of</a> §8.2.2.2	<a href="#">urn:oasis:names:tc:SAML:2.0:status:RequestUnsupported</a> §7.4.2
<a href="#">definition of</a> §8.2.3	<a href="#">definition of</a> §8.2.3	<a href="#">urn:oasis:names:tc:SAML:2.0:status:Responder</a> §7.4.1
<a href="#">definition of</a> §8.3.1.1	<a href="#">definition of</a> §8.3.1	
<a href="#">definition of</a> §8.3.1.2	<a href="#">definition of</a> §8.3.1.1	
<a href="#">definition of</a> §8.3.2	<a href="#">definition of</a> §8.3.1.2	
<a href="#">ProviderID</a> §7.1.2.1.2	<a href="#">definition of</a> §8.3.2	
<a href="#">ProviderName</a> §7.1.2.1.2		validUntil
<a href="#">RD</a> §3.2	SingleLogoutService	<a href="#">definition of</a> §8.2.1
Recipient	<a href="#">definition of</a> §8.2.1	<a href="#">definition of</a> §8.2.2
<a href="#">definition of</a> §7.1.2.4.4.3	<a href="#">definition of</a> §8.2.2.1	<a href="#">definition of</a> §8.2.2.1
<a href="#">definition of</a> §7.1.2.4.6	<a href="#">definition of</a> §8.2.3	<a href="#">definition of</a> §8.2.2.2
<a href="#">Represented Party</a> §3.1	<a href="#">definition of</a> §8.3.1.1	<a href="#">definition of</a> §8.2.3
<a href="#">RequestedAttribute</a> §8.2.1	<a href="#">definition of</a> §8.3.2	<a href="#">definition of</a> §8.3.1
<a href="#">RequesterID</a> §7.1.2.1.2	SingleSignOnService	<a href="#">definition of</a> §8.3.1.1
<a href="#">Response</a> §7.1.2.4.2	<a href="#">definition of</a> §8.2.3	<a href="#">definition of</a> §8.3.1.2
<a href="#">Roles</a> §3.2	<a href="#">definition of</a> §8.3.2	<a href="#">definition of</a> §8.3.2
<a href="#">SAML</a> §3.1	<a href="#">SLO</a> §3.1	Value
<a href="#">Scoping</a> §7.1.2.1.2	SPSSODescriptor	<a href="#">definition of</a> §7.1.2.4.2
<a href="#">Service</a> §3.1	<a href="#">definition of</a> §8.2.1	<a href="#">definition of</a> §7.1.2.4.2
<a href="#">Service Catalog</a> §3.1	<a href="#">definition of</a> §8.2.2.1	<a href="#">definition of</a> §7.1.2.4.3
<a href="#">Service Consumer</a> §3.1	<a href="#">definition of</a> §8.2.2.2	<a href="#">definition of</a> §7.1.2.4.3
<a href="#">Service Definition</a> §7.1.2.1.2.1	<a href="#">definition of</a> §8.3.1.1	
<a href="#">ServiceName</a> §8.2.1	<a href="#">definition of</a> §8.3.1.2	Version
<a href="#">ServiceUUID</a> §3.1	<a href="#">SSO</a> §3.1	<a href="#">definition of</a> §7.1.2.1.2
SessionIndex	<a href="#">ST-SAML</a> §3.1	<a href="#">definition of</a> §7.1.2.3.2
<a href="#">definition of</a> §7.1.2.4.4	Status	<a href="#">definition of</a> §7.1.2.4.2
<a href="#">definition of</a> §7.3.1.3	<a href="#">definition of</a> §7.1.2.4.2	<a href="#">definition of</a> §7.1.2.4.3
	<a href="#">definition of</a> §7.1.2.4.3	<a href="#">definition of</a> §7.3.1.3
	<a href="#">definition of</a> §7.3.1.5	<a href="#">definition of</a> §7.3.1.5
	StatusCode	
	<a href="#">definition of</a> §7.1.2.4.2	<a href="#">WantAssertionsSigned</a>
	<a href="#">definition of</a> §7.1.2.4.2	<a href="#">definition of</a> §8.2.1
	<a href="#">definition of</a> §7.1.2.4.3	<a href="#">definition of</a> §8.2.2.1
	<a href="#">definition of</a> §7.1.2.4.3	<a href="#">definition of</a> §8.3.1.1
	<a href="#">definition of</a> §7.3.1.5	<a href="#">WantAuthnRequestsSigned</a>
	StatusMessage	<a href="#">definition of</a> §8.2.3
	<a href="#">definition of</a> §7.1.2.4.2	<a href="#">definition of</a> §8.3.2
	<a href="#">definition of</a> §7.1.2.4.3	
	<a href="#">Subject</a> §7.1.2.4.4	
	SubjectConfirmation	
	<a href="#">definition of</a> §7.1.2.4.4	
	<a href="#">definition of</a> §7.1.2.4.4.3	

X509Data

[definition of §8.2.1](#)

[definition of §8.2.2.1](#)

[definition of §8.2.2.2](#)

[definition of §8.2.3](#)

[definition of §8.3.1.1](#)

[definition of §8.3.1.2](#)

[definition of §8.3.2](#)

## §D.2 Terms defined by reference

## §E. References

### §E.1 Normative references

#### [BSNk.DEC]

*BSNk PP technische specificaties*. Logius. URL: <https://gitlab.com/logius/bsnk/bsnk-techspecs/bsnk/-/raw/main/BPTSlive.pdf>

#### [DigiD SAML3.x]

*DigiD SAML3.x - legacy SAML specification for DigiD*. LOGIUS. URL: <https://www.logius.nl/domeinen/toegang/digid/documentatie/koppelvlakspecificatie-digid-saml-authenticatie>

#### [eID SAML4.4]

*eID SAML4.4 specification for DigiD*. LOGIUS. URL: <https://logius.gitlab.io/eid-saml/4.4/index.html>

#### [eID SAML4.5]

*eID SAML4.5 specification for DigiD*. LOGIUS.

#### [NCSC.TLS]

*ICT-beveiligingsrichtlijnen voor Transport Layer Security (TLS)*. NCSC. URL: <https://www.ncsc.nl/transport-layer-security/ICT-beveiligingsrichtlijnen-voor-TLS>

#### [NORA]

*Nederlandse Overheid Referentie Architectuur*. URL: [https://www.noraonline.nl/wiki/NORA\\_online](https://www.noraonline.nl/wiki/NORA_online)

#### [RFC2119]

*Key words for use in RFCs to Indicate Requirement Levels*. S. Bradner. IETF. March 1997. Best Current Practice. URL: <https://www.rfc-editor.org/rfc/rfc2119>

#### [RFC8174]

*Ambiguity of Uppercase vs Lowercase in RFC 2119 Key Words*. B. Leiba. IETF. May 2017. Best Current Practice. URL: <https://www.rfc-editor.org/rfc/rfc8174>

#### [SAML2]

*Security Assertion Markup Language (SAML) V2.0*. OASIS. URL: <https://www.oasis-open.org/standard/saml/>

#### [SAML2.BINDINGS]

*Bindings for the OASIS Security Assertion Markup Language (SAML) V2.0 – Errata Composite*. OASIS. URL: <https://groups.oasis-open.org/higherlogic/ws/public/download/56779/sstc-saml-bindings-errata-2.0-wd-06.pdf>

#### [SAML2.CORE]

*Assertions and Protocols for the OASIS Security Assertion Markup Language (SAML) V2.0 – Errata Composite*. OASIS. URL: <https://groups.oasis-open.org/higherlogic/ws/public/download/56776/sstc-saml-core-errata-2.0-wd-07.pdf>

#### [SAML2.ERRATA.05]

*SAML Version 2.0 Errata 05*. OASIS. URL: <https://docs.oasis-open.org/security/saml/v2.0/sstc-saml-approved-errata-2.0.html>

#### [SAML2.METADATA]

*Metadata for the OASIS Security Assertion Markup Language (SAML) V2.0 – Errata Composite*. OASIS. URL: <https://groups.oasis-open.org/higherlogic/ws/public/download/56785/sstc-saml-metadata-errata-2.0-wd-05.pdf>

**[SAML2.PROFILES]**

*Profiles for the OASIS Security Assertion Markup Language (SAML) V2.0 – Errata Composite*. OASIS. URL: <https://groups.oasis-open.org/higherlogic/ws/public/download/56782/sstc-saml-profiles-errata-2.0-wd-07.pdf>

**[SAML2.TO]**

*Security Assertion Markup Language (SAML) V2.0 Technical Overview*. OASIS. URL: <https://docs.oasis-open.org/security/saml/Post2.0/sstc-saml-tech-overview-2.0.html>

**[ST-SAML1.0]**

*Stelsel Toegang SAML v1.0 specification*. LOGIUS. URL: <https://logius.gitlab.io/digid-combiconnect>

**[XML.C14N.EXCL]**

*Exclusive XML Canonicalization*. W3C. URL: <https://www.w3.org/TR/xml-exc-c14n/>

**[XML.ENC]**

*XML Encryption Syntax and Processing*. W3C. URL: <https://www.w3.org/TR/2002/REC-xmlenc-core-20021210/>

**[XML.SIG]**

*XML Signature Syntax and Processing*. W3C. URL: <https://www.w3.org/TR/xmldsig-core/>